



# BX1976

## 2007-11 Dodge Nitro 2008-11 Jeep Liberty Installation Instructions

**Please read BOTH these Installation Instructions and the General Information sheet prior to installing or operating this equipment.**

1. Blue Ox® towing products and accessories are intended to be installed by Blue Ox® Dealers who are familiar with our products and have the equipment and knowledge necessary to do “fit work”. If needed, Blue Ox® Dealers can be found at [www.blueox.com](http://www.blueox.com) or by contacting our Technical Service Department at (402) 385-3051.
2. Many Blue Ox® baseplates are designed to use existing holes and hardware to mount the baseplate to the towed vehicle. Even though bolts are there, do not assume they are adequate for baseplate mounting. Always use the hardware supplied in the hardware kit and existing hardware as specified in the installation instructions.



If the front of your vehicle looks different than this, please contact us at (402)385-3051.

**Serial Number**

**Attachment Tab Height: 17-1/2”**

**Attachment Tab Width: 20”**

### Bolt Torque Specifications

Torque in Foot-Pounds for Inch Bolts

Bolt Size	Grade 5	Grade 8
1/4"	10	14
5/16"	19	29
3/8"	33	47
7/16"	54	78
1/2"	78	119
5/8"	154	230
3/4"	257	380

### Bolt Torque Specifications

Torque in Foot-Pounds for Metric Bolts

Bolt Size	Grade 8.8	Grade 10.9
6MM	6	8
8MM	16	22
10MM	31	40
12MM	54	70
14MM	89	117
16MM	161	230
18MM	222	318



## WARNING

Failure to read and follow these instructions could result in separation of the towed vehicle from the tow bar, causing property damage, loss of towed vehicle, personal injury or death.

**Reference your vehicle owner’s manual for manufacturer’s towing specifications.**

BX1976  
2007-11 Dodge Nitro  
2008-11 Jeep Liberty  
Installation Instructions

**Instruction Notes:** The fascia and grille (Dodge only) are removed and reinstalled for the baseplate installation. Some drilling and trimming is required.

Place all components that are removed on a flat, sturdy surface. All items will be reinstalled unless otherwise noted after the baseplate is installed.

The dimensional variations between otherwise identical vehicles can be considerable. While the baseplate was designed for easy installation, it may be necessary to tailor the baseplate slightly to compensate for vehicle manufacturer's tolerances.

The BX8869 Tail Light Wiring Kit is recommended for this vehicle.

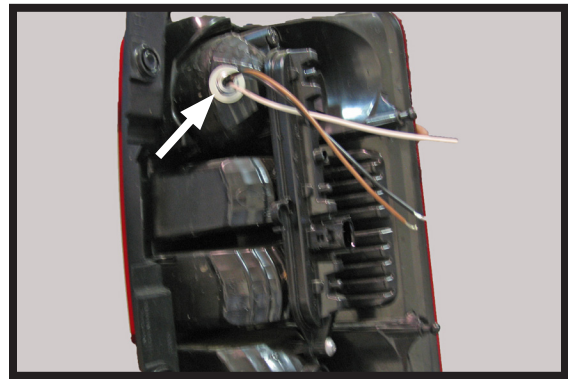
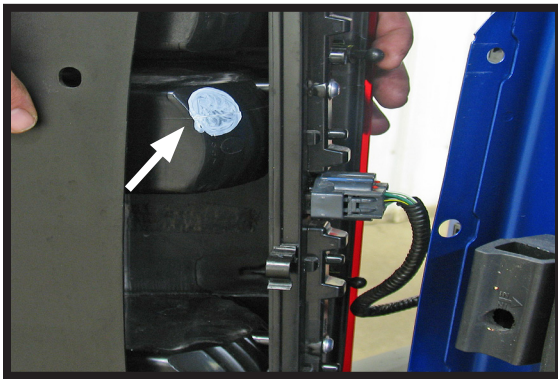

Drill a hole according to the tail light wiring kit instructions.

### **NOTICE**

- Handling of some cosmetic parts when installing this product may require the use of protective covers, rags, specialty tools, etc. to prevent damage.
- When using power drills be aware of the dangers of torque and drill bit length.
- When using a reciprocating saw be aware of objects behind the cutting surface.
- Use a good quality paint to spray cut edges of frame to prevent rusting.
- Be sure that **ALL** electrical connections are plugged in and accessories are functioning properly before reinstalling the fascia.
- The baseplate is computer tested to your vehicle's GVWR, exceeding this weight will void the manufacturer's warranty.
- Be sure to use a sufficient amount of Loctite® Red on all bolt threads before tightening. Tighten all bolts according to the torque chart provided.
- Dealer or installer be certain the user receives these instruction sheets.
- If the baseplate is in an accident, it must be replaced. **DO NOT** use it again! An accident can cause unseen damage and using it again could result in more damage or serious injury. **DO NOT** use the baseplate if it is damaged or missing parts.

BX1976  
2007-11 Dodge Nitro  
2008-11 Jeep Liberty  
Installation Instructions

**Tools Required**

Large Vise Grip	Loctite® RED
Flat Screwdriver	13/32" Drill Bit
Utility Knife	10MM Socket
Torque Wrench	9/16" Socket
Tape Measure	T25 Torx
Drill	

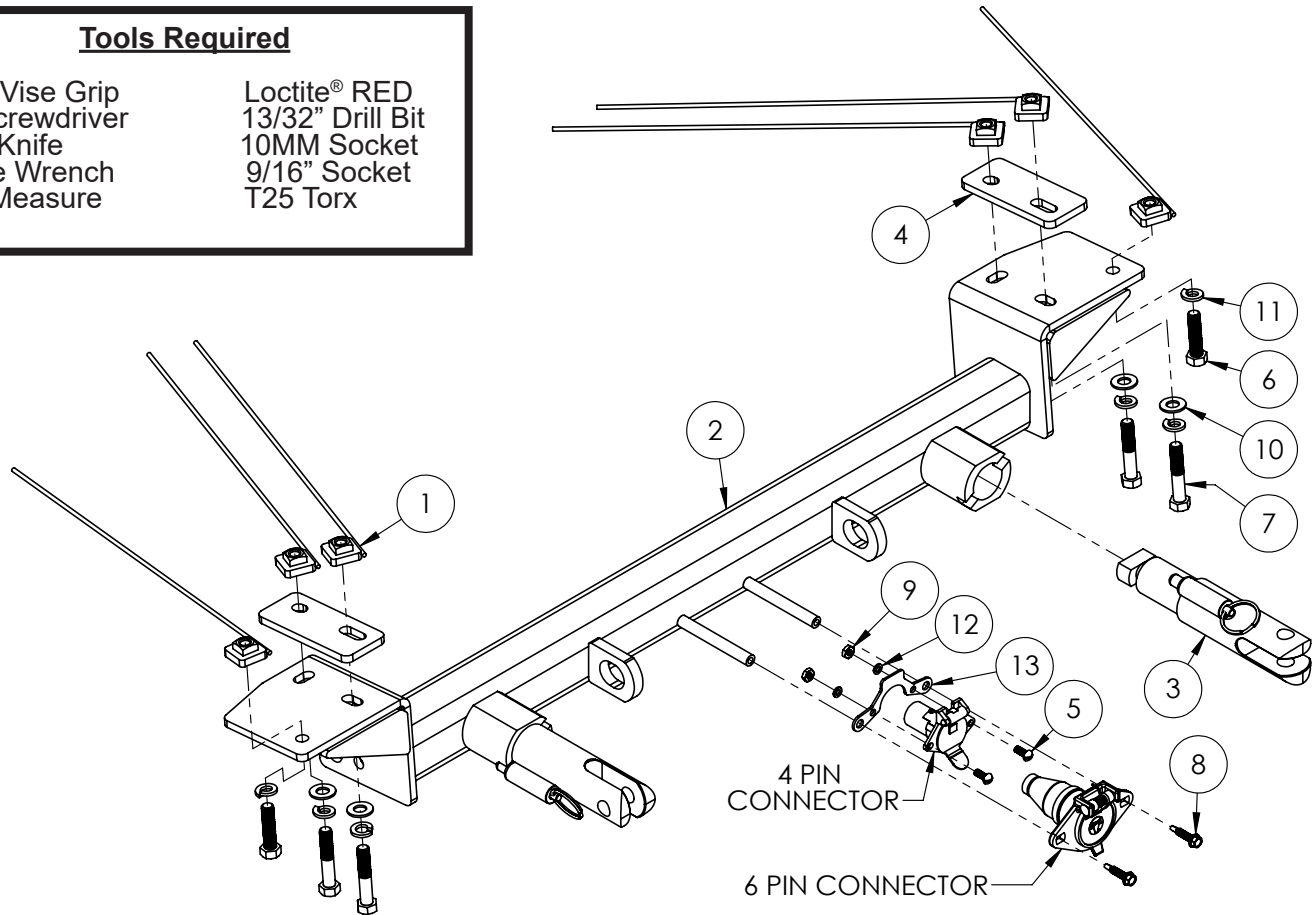

Item No.	Part No.	Description	Qty.
1.....	61-5208.....	3/8" Nut Plate w/ 14" Wire .....	6
2.....	61-6357.....	BX1976 Baseplate.....	1
3.....	62-3468.....	Attachment Tab Assembly with Hole .....	2
4.....	102-6572.....	Backing Plate .....	2
5.....	201-0192.....	#10-32 1/2" Round Slotted Head Screw.....	2
6.....	201-0440.....	3/8"-16 x 1-1/2" Hex Head Bolt, Grade 5, ZP .....	2
7.....	201-0444.....	3/8"-16 x 2" Hex Head Bolt, Grade 5, ZP .....	4
8.....	201-0979.....	#12-14 x 1" Self Drilling Screw, ZP.....	2
9.....	202-0047.....	#10-32 Hex Nut.....	2
10.....	203-0003.....	3/8" Flat Washer .....	4
11.....	203-0010.....	3/8" Lock Washer, ZP.....	6
12.....	203-0054.....	#10 Lock Washer, ZP .....	2
13.....	299-0685.....	Electrical Bracket.....	1
14.....	226-0046(not shown).....	Class III Safety Cables .....	2
15.....	229-0359(not shown).....	3/8" Quicklink, ZP .....	2
16.....	229-0536(not shown).....	6.3MM Plastic Rivet.....	4
17.....	290-0437(not shown).....	Black Cap Plug Receiver.....	2

**Important:**

Use only genuine factory replacement parts on your baseplate. Do **NOT** substitute homemade or non-typical parts. If a bolt is lost or in need of replacement, for your safety and the preservation of your baseplate, be sure to use a replacement bolt of the same grade (In most cases it will be Grade 5, please reference the parts list above). Replacement parts may be ordered through your nearest Blue Ox® Dealer or Distributor. Failing to follow and/or altering these installation instructions in either installation or required equipment will void the manufacturer's warranty. Towing behind a non-motorized vehicle will void the warranty.

BX1976  
2007-11 Dodge Nitro  
2008-11 Jeep Liberty  
Installation Instructions



1. **DODGE ONLY:** Using a flat screwdriver, remove two pushpins just forward the front tire, on the wheel well. Set pushpins aside to be reinstalled later. Do this to both sides of the vehicle.



2. **JEEP ONLY:** Remove three push pins and lower two pop rivets with the flat screwdriver and side cutters. Do this to both sides of the vehicle.

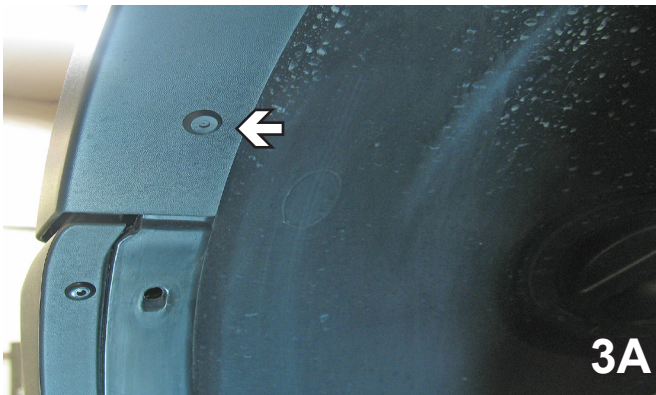

3. **DODGE ONLY:** Using a diagonal cutters, cut off pop rivet located above the top pushpin (see photo 3A). Then pull plastic back to locate and remove pushpin. The pop rivet will be replaced with a new one from the bolt bag and the pushpin will be set aside to be reinstalled later. Do this to both sides of the vehicle.



4. **BOTH VEHICLES:** After removing the pop rivet and pushpin, pull plastic back far enough to reach the top silver bolt. Using a 10MM socket, remove bolt and set aside to be reinstalled later. Do this to both sides of the vehicle.

BX1976  
2007-11 Dodge Nitro  
2008-11 Jeep Liberty  
Installation Instructions

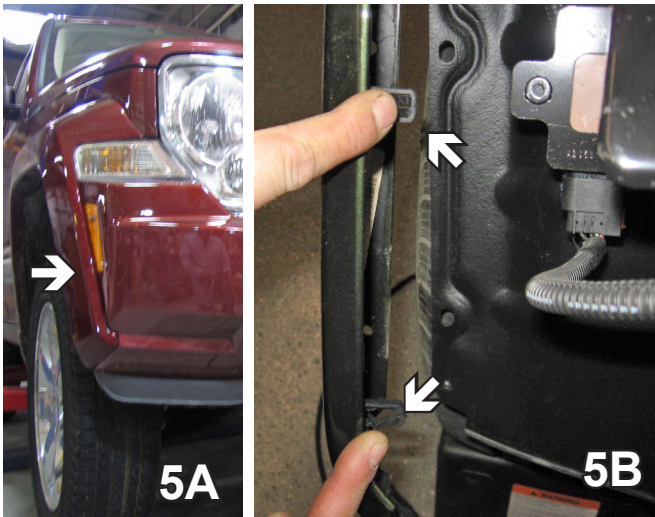

5. **JEEP ONLY:** While pulling fender flare out to the side, release the three clips forward of front tire wheel well on lower fascia cover. Do this to both sides.

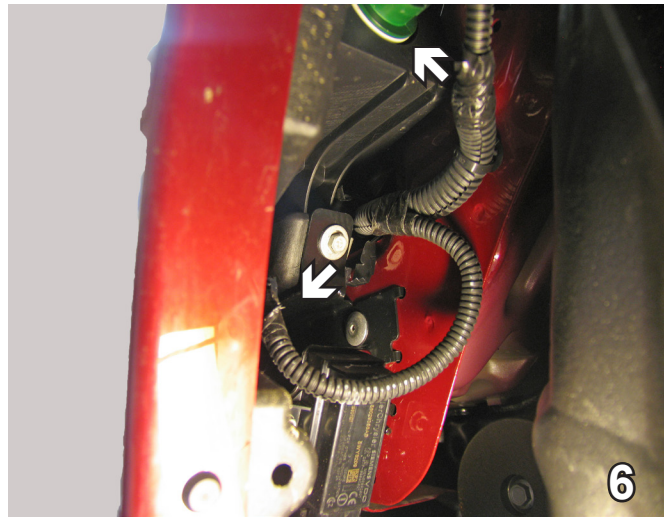

6. **JEEP ONLY:** Unplug two lights, the green one and the black one. Do this to both sides of the vehicle.



7. **JEEP ONLY:** Underneath the front fascia, using a flat screwdriver remove the plastic push pin. Do this to both sides of the vehicle.

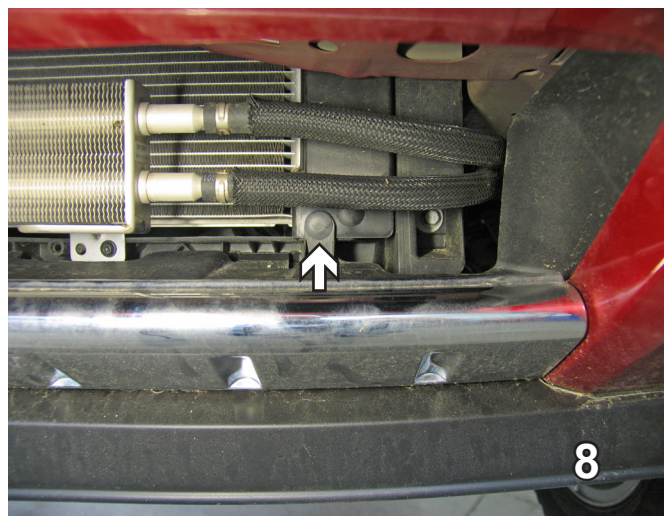

8. **JEEP ONLY:** Using a flat screwdriver in front remove two more push pins, one on each side. (Some models may have three pushpins.) Pull fascia corners out to the side and then forward to release. Set fascia aside carefully to be reinstalled later. (JEEP: Go to Step 14)

BX1976  
2007-11 Dodge Nitro  
2008-11 Jeep Liberty  
Installation Instructions

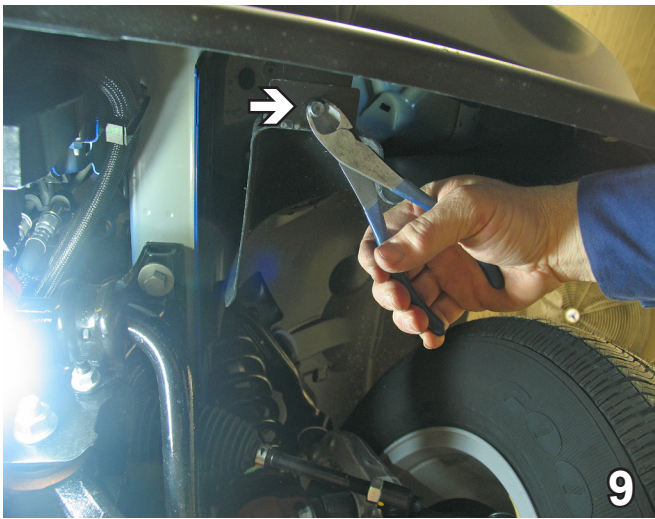

9. **DODGE ONLY:** Using a diagonal cutters, remove the pop rivet from the plastic skid pan underneath bumper. New pop rivets found in the bolt bag, will be installed later. Do this to both sides of the vehicle.

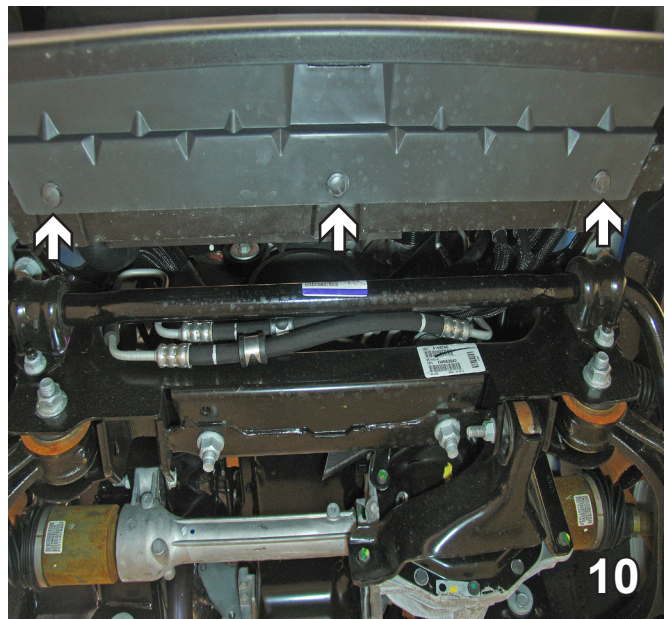

10. **DODGE ONLY:** Using a flat screwdriver, remove three pushpins from underneath the bumper. Set pushpins aside to be reinstalled later.

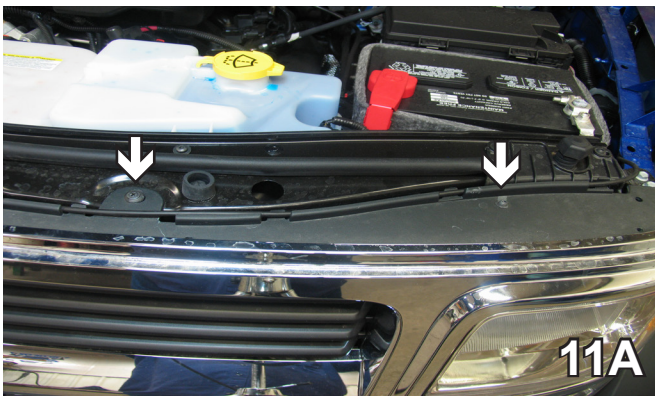

11. **DODGE ONLY:** Remove two pushpins with a flat screwdriver (see photo 11B) and a metric bolt with a 25 torx bit from the top edge of the grille (see photo 11A). Set pushpins and bolt aside to be reinstalled later. Do this to both sides of the vehicle.

BX1976  
2007-11 Dodge Nitro  
2008-11 Jeep Liberty  
Installation Instructions

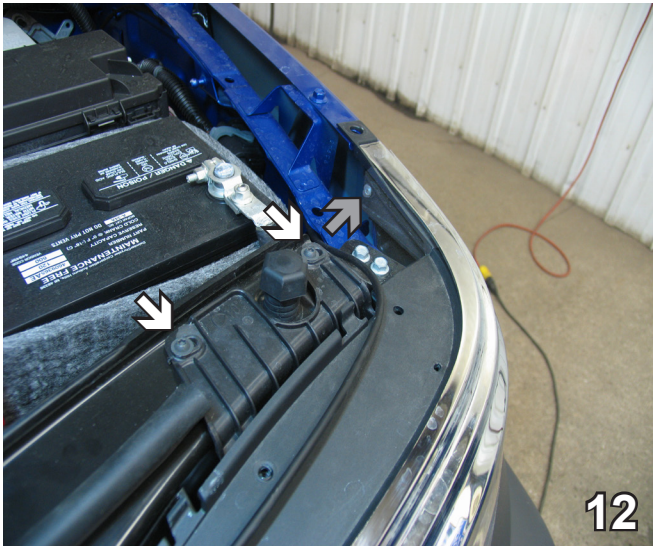

12. **DODGE ONLY:** Using a 25 torx bit, remove two metric bolts right in front of the battery (see white arrow). Then remove a metric bolt located in the corner, from both sides of the vehicle (see grey arrow). Set bolts aside to be reinstalled later.

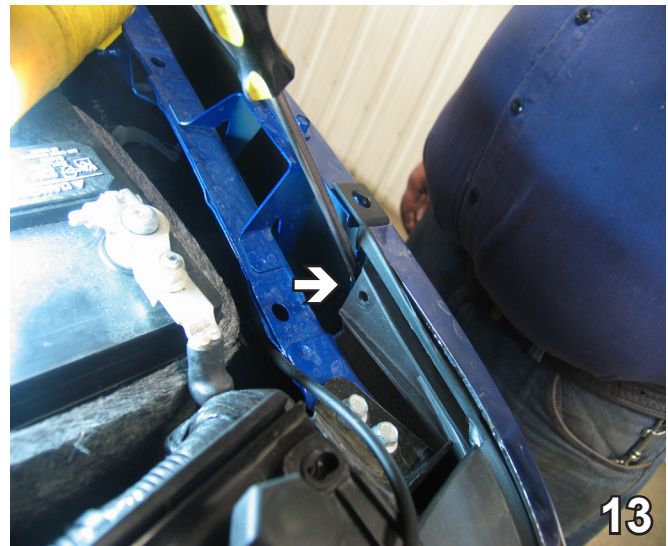

13. **DODGE ONLY:** Using a flat screwdriver, pull plastic forward to loosen. Do this to both sides of the vehicle. The bumper and grille can then be removed and carefully set aside to be reinstalled later.

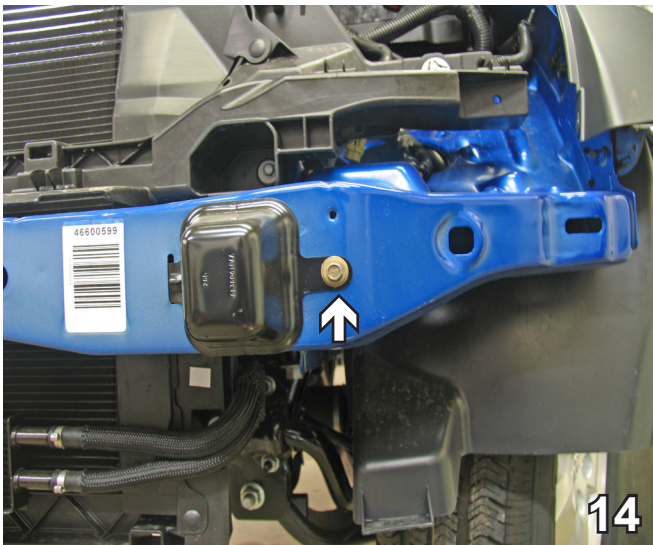

14. **BOTH VEHICLES:** Remove the metric bolt from the bumper hub with a 10MM socket. Set hub and bolt aside to be reinstalled later. Do this to both sides of the vehicle.

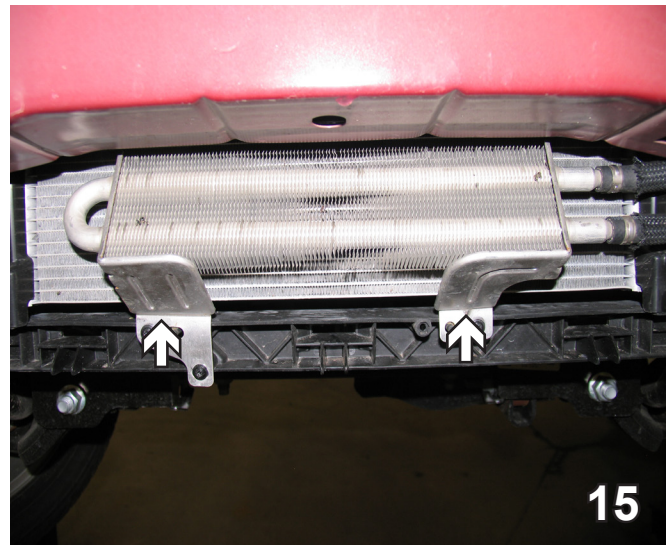

15. **JEEP ONLY:** Under the transmission cooler, bend the brace brackets up to 45°. Being careful not to damage radiator behind transmission cooler.

BX1976  
2007-11 Dodge Nitro  
2008-11 Jeep Liberty  
Installation Instructions

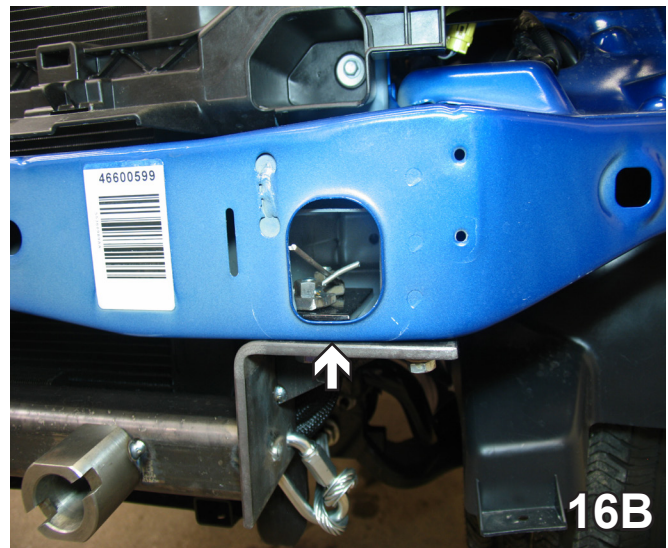
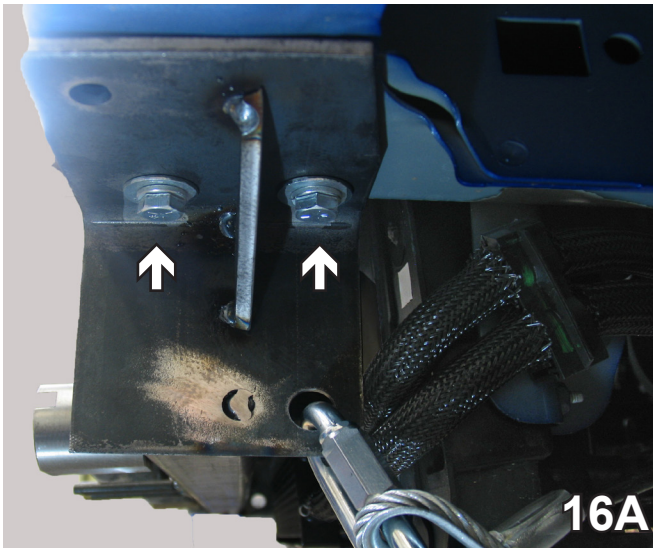

16. **BOTH VEHICLES:** Align the baseplate with the two existing holes in the bottom of the frame, insert backing plate and 3/8-16 nut plates into the opening on the end of the frame rail to align with these existing holes. Some vehicles may need to have these existing holes reamed with the 13/32" drill bit to acquire the proper fit. Tighten the 3/8-16x2" hex bolts, 3/8" flat washers and 3/8" lock washers with the 9/16" socket. Do this to both sides of the vehicle.

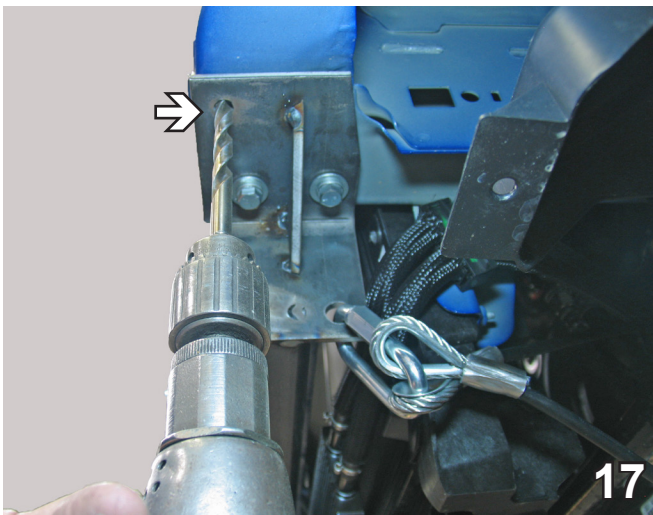

17. **BOTH VEHICLES:** Using the baseplate as a template, drill a hole into the frame rail with the 13/32" drill bit. Insert the 3/8-16 nut plate into the opening on the back side of the frame support to align with the drilled hole, tighten the 3/8-16 1 1/2" hex bolt and 3/8" lock washer with the 9/16" socket. Do this to both sides of the vehicle.

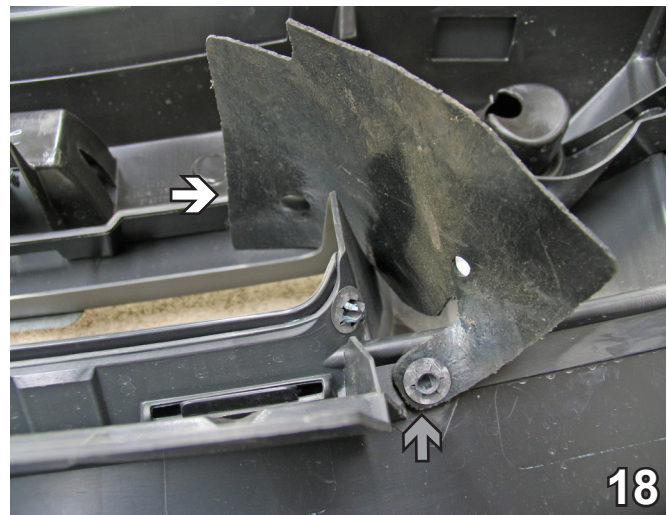

18. **DODGE ONLY:** Remove rubber piece from the backside of the fascia, by first removing the pushpin with a flat screwdriver (white arrow) and then cutting right next to the clip with a utility knife (gray arrow). The rubber piece should be completely removed and discarded. Do this to both sides of the fascia.



BX1976  
2007-11 Dodge Nitro  
2008-11 Jeep Liberty  
Installation Instructions



19. **BOTH VEHICLES:** Attach the permanent baseplate safety cables to the provided convenience link on the baseplate. The photo above shows the recommended installation of the cables to frame of vehicle. Additional options may interfere with suggested mounting; in this case, secure the cables to a solid piece of the frame as described in the General Information sheet. Be sure the safety cables do not rub against any hoses or moving parts. Do this on **BOTH** sides of the vehicle.



20. **DODGE ONLY:** Trim corner of fascia as shown in photos above. The amount of trimming required will vary, depending on what you need to get fascia reinstalled around baseplate. Do this to both sides of the vehicle.



21. **JEEP ONLY:** On the back side of the fascia, trim corner 1 1/2" x 1 1/2" as shown in photos above. Do this to both corners of the fascia.

22. Reinstall bumper hubs, bumper and the grille. Replace the plastic rivets for Step 2, 3 and Step 8 with the ones provided.

BX1976  
2007-11 Dodge Nitro  
2008-11 Jeep Liberty  
Installation Instructions



**CUSTOMER SERVICE COMMITMENT**

Blue Ox® is committed to providing you with exceptional customer care throughout your lifetime with our products. Our team is here to assist you with any questions you may have regarding the performance of your product. Simply call (402) 385-3051 and you can speak with our technical service team.

Additionally, please visit our website to see which rallies our Destination America team will be attending. For a nominal fee, our service technician will service your towing system to ensure it's in proper working condition. Also, as a commitment to our customers, should you visit our factory, you can stay at our full service Blue Ox® campground at no charge along with enjoying a factory tour.

Again, thank you for being our customer and for the confidence you have shown in the performance of our products. It is because of customers like you we enjoy the success we have today.

© 2016 Blue Ox  
One Mill Road, Industrial Park  
Pender, Nebraska 68047  
Phone: (402) 385-3051  
Fax: (402) 385-3360  
[www.blueox.com](http://www.blueox.com)

# General Information

1. Ensure that your product(s) are registered online at [www.blueox.com](http://www.blueox.com). It is crucial to register your product(s) so that you may be alerted of product offerings, updates, upgrades, maintenance and safety bulletins, and/or recalls.
2. **It is the owner's responsibility to inspect all towing equipment for cracked welds, missing or worn parts and loose bolts before each towing trip.** Be sure to use Loctite® Red on all bolts and tighten to the recommended specifications.
3. **It is the owner's responsibility to hook up all towing equipment per manufacturer's instructions/recommendations.**
4. Remove the attachment tabs when not in use (if applicable).

## Notice To Baseplate Installer

### 1. It is YOUR responsibility to watch for:

- Oil cooler and air conditioner lines
- Electrical wires and hoses
- Missing parts or attaching points on the frame

\*\* If the baseplate is improperly installed and is against a wire or hose, it could cause fluid leaks or electrical shorts some time after the actual baseplate installation.

## Permanent Baseplate Safety Cable Installation

Permanent baseplate safety cables are strongly recommended when towing a vehicle with a tow bar. The principle function of the permanent baseplate safety cables is to prevent the towed vehicle from breaking loose in the event the connection between the frame of the towed vehicle and the baseplate fails or becomes disconnected. The cables must be connected from the baseplate to the frame rail or cross member of the vehicle's frame. The illustrations below show the possible arrangements recommended by Blue Ox®. Each permanent baseplate safety cable must have an adequate weight rating for the towing system. The weight rating of the two (2) cables together will not qualify.

***Do not mount the permanent baseplate safety cables against wires, hoses or brake lines.***

These permanent baseplate safety cables should remain installed as long as the baseplate is installed on the vehicle. Permanent baseplate safety cables are to be used in conjunction with, and NOT a replacement for legally required safety cables attaching the towed vehicle to the towing vehicle.

### OPTION #1

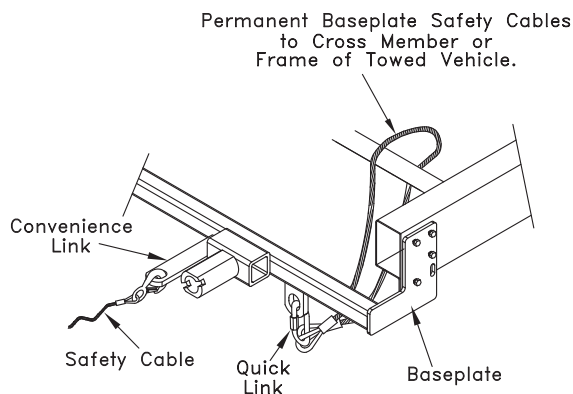

### OPTION #2

