

15402

FORD F-350

3/3/2021

GROSS LOAD CAPACITY WHEN USED AS A WEIGHT CARRYING HITCH: 17,000 LBS. TRAILER WEIGHT & 2,550 LBS. TONGUE WEIGHT. GROSS LOAD CAPACITY WHEN USED AS A WEIGHT DISTRIBUTION HITCH: 17,000 LBS. TRAILER WEIGHT & 2,550 LBS. TONGUE WEIGHT



WARNING: * DO NOT EXCEED VEHICLE MANUFACTURER'S RECOMMENDED TOWING CAPACITY. *****

FOR MORE INFORMATION LOG ONTO WWW.CURTMFG.COM

HAVING INSTALLATION QUESTIONS? CALL TECHNICAL SUPPORT AT 1-877-287-8634



Parts List			
ITEM	QTY	PART NUMBER	DESCRIPTION
1	12	10-10292	BOLT, CAR,5/8-11 UNC,1-3/4,GRD8,YZ
2	12	20-00105	NUT, SER-FLANGE,5/8-11 UNC,GRD8,YZ
3	2	15402-SP	SPACER

TOOLS REQUIRED	
	RATCHET
	TORQUE WRENCH
	15/16" SOCKET

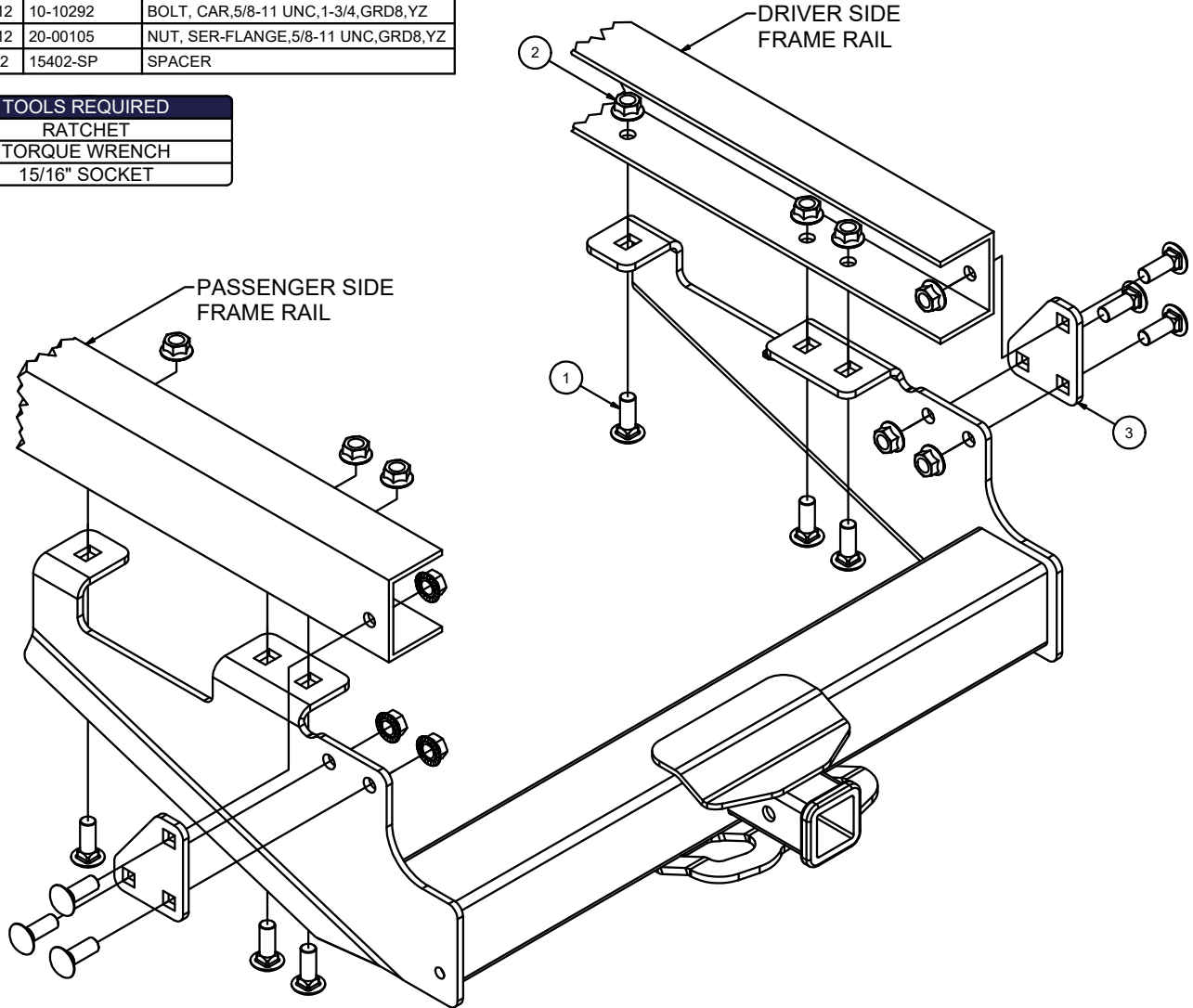

HITCH WEIGHT: 69 LBS.

INSTALL TIME

PROFESSIONAL: 20 MINUTES

NOVICE (DIY): 40 MINUTES

INSTALL NOTES:

- NO DRILLING REQUIRED

INSTALLATION STEPS

1. Raise hitch into position and loosely secure the hitch to the frame as shown with 5/8" carriage bolts going up into the frame.
2. Attach the mounting plates to the hitch and fasten to the truck as shown.
3. Torque all 5/8" hardware to 180 ft-lbs.

PERIODICALLY CHECK THIS RECEIVER HITCH TO ENSURE THAT ALL FASTENERS ARE TIGHT AND THAT ALL STRUCTURAL COMPONENTS ARE SOUND.



Scan for more information

CURT Manufacturing LLC., warrants this product to be free of defects in material and/or workmanship at the time of retail purchase by the original purchaser. If the product is found to be defective, CURT Manufacturing LLC., may repair or replace the product, at their option, when the product is returned, prepaid, with proof of purchase. Alteration to, misuse of, or improper installation of this product voids the warranty. CURT Manufacturing LLC.'s liability is limited to repair or replacement of products found to be defective, and specifically excludes liability for incidental or consequential loss or damage.

This product complies with safety specifications and requirements for connecting devices and towing systems of the state of New York, V.E.S.C.Regulation V-5 and SAE J684.