

# INSTALLATION MANUAL

# 13473

## Level of Difficulty

Easy

Installation difficulty levels are based on time and effort involved and may vary depending on the installer level of expertise, condition of the vehicle and proper tools and equipment.

## Weight Carrying Capacity

Gross trailer weight (GTW)	4,000 lbs.
Tongue weight (TW)	600 lbs.

## Parts List

Item	Qty	Description
1	6	Hex bolt, M12-1.25 x 40mm, CL8.8
2	6	Conical-toothed washer, 1/2"

## Tools Required

Torque wrench	Ratchet
Socket extension, 3"	Exhaust removal tool
Socket extension, 6"	Flathead screwdriver
Socket, 3/8"	Wrench, 1" or larger
Socket, 19mm	--

\* For a tools reference guide visit [curtmfg.com/trailer-hitch-installation](http://curtmfg.com/trailer-hitch-installation)

## ⚠ WARNING

Never exceed the vehicle manufacturer's recommended towing capacity.

## Product Photo



## NOTICE

Visit [www.curtmfg.com](http://www.curtmfg.com) for a full-color copy of this instruction manual, as well as helpful videos, guides and much more!

Before you begin installation, read all instructions thoroughly.

Proper tools will improve the quality of installation and reduce the time required.

This installation requires:

- Lowering of the spare tire
- Lowering of the exhaust
- Exhaust rod bending
- Part removal

Periodic inspection of the trailer hitch should be performed to ensure all mounting hardware remains tight and structural components are secure.

To help prevent damage to the product or vehicle, refer to the specified torque specifications when securing hardware during the installation process.

## SAFETY INSTRUCTIONS

Safety glasses should be worn at all times while installing this product.

## Product Registration and Warranty

CURT stands behind our products with industry-leading warranties. To get copies of the product warranties, register your purchase or provide feedback, visit: [warranty.curtgroup.com/surveys](http://warranty.curtgroup.com/surveys)

# ASSEMBLY

## Parts List

Item	Qty	Description
1	6	Hex bolt, M12-1.25 x 40mm, CL8.8
2	6	Conical-toothed washer, 1/2"

Existing M12 weldnuts (both sides)

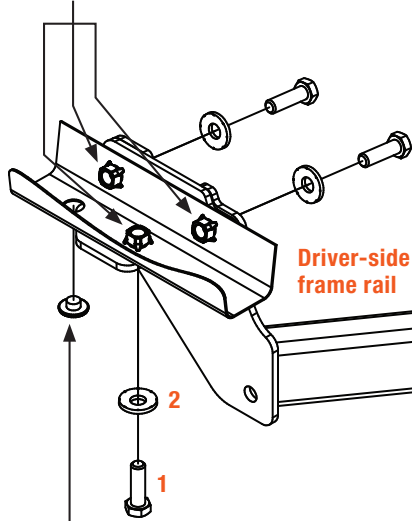

Existing rubber plug (both sides)

Passenger-side frame rail

Frame rail exhaust hanger rod

Exhaust hanger rod (two places)

Rubber isolator (two places)

Exhaust

Rubber isolator  
Exhaust hanger rods

FRONT

REAR

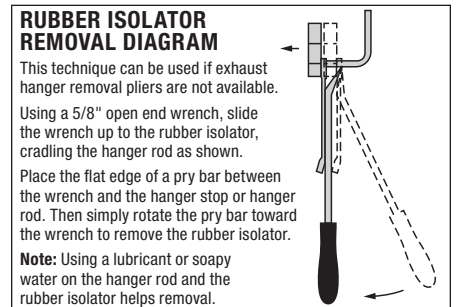
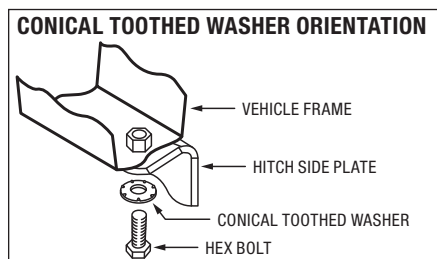
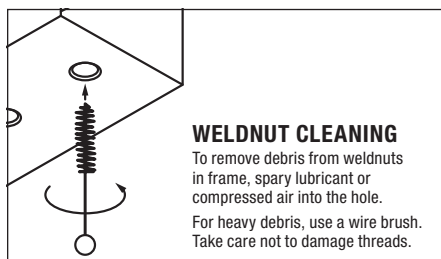

## Step 1

**For Kia Sorento models only:** Remove the plastic cover by removing the three lower plastic clips located on driver side near the wheel well and gently pulling straight down.

If the plastic cover cannot be removed by pulling down, unscrew the two upper plastic nuts by hand until you are able to remove the plastic cover. Set the plastic cover aside for reinstallation in Step 6.

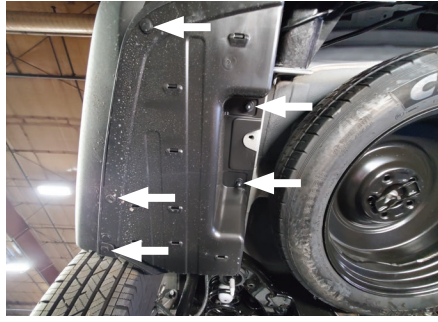

## Step 2

**For models with a spare tire:** Loosen the spare tire carrier nut using a 3/8" socket. Lower the spare tire and set aside for reinstallation in Step 6.





### Step 3

**All models:** Lower the exhaust by removing the four rearmost exhaust hanger rods from the three rubber isolators. Use a stand to support the exhaust and prevent any damage.

The exhaust will be reinstalled in Step 6.



### Step 4

**All models:** Remove one rubber plug from the bottom of the frame rail on both sides. Return to the owner.





## Step 5

**All models:** Raise the trailer hitch into position by sliding the passenger side of the hitch over the exhaust first. On both sides of the vehicle, align the three holes in the hitch with the three weld nuts in the frame rail.

Loosely install three hex bolts (#1) and three conical washers (#2) into the hitch holes and weld nuts on both sides.

Torque all M12 fasteners to 60 ft-lbs.

**Note:** After installation, inspect the hitch and exhaust to make sure there is adequate clearance. If additional clearance is needed between the hitch and exhaust, remove the rearmost rubber isolator from the frame-rail exhaust hanger rod. Adjust the rail exhaust hanger rod down approximately five degrees using a box end wrench as shown. Reinstall the rubber isolator.

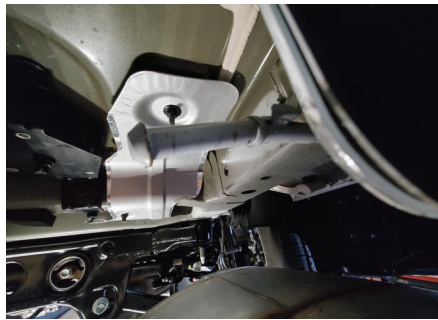
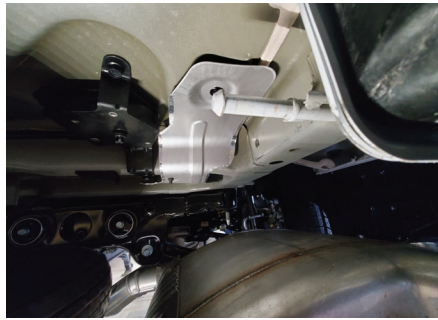
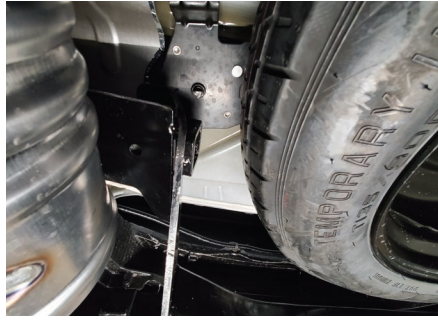

## Step 6

**All models:** Reinstall the plastic cover, spare tire and exhaust removed in Steps 1 through 3.

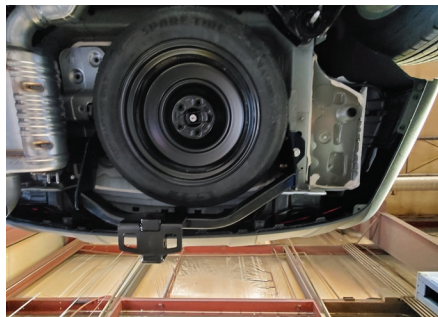

## Final Installed Image



## TOWING BASICS & SAFETY INFORMATION

For information on safely towing your trailer, visit [curtmfg.com/understanding-towing](https://curtmfg.com/understanding-towing).