

11285

92-95 TOYOTA PASEO

3/22/2013

GROSS LOAD CAPACITY WHEN USED AS A WEIGHT CARRYING HITCH: 2,000 LBS. TRAILER WEIGHT & 200 LBS. TONGUE WEIGHT.

*****DO NOT EXCEED VEHICLE MANUFACTURER'S RECOMMENDED TOWING CAPACITY.*****

WARNING: ALL NON-TRAILER LOADS APPLIED TO THIS PRODUCT MUST BE SUPPORTED BY 18050 STABILIZING STRAPS.

**** FAILURE TO PROPERLY SUPPORT NON-TRAILER LOADS WILL VOID PRODUCT WARRANTY****

HAVING INSTALLATION QUESTIONS? CALL TECHNICAL SUPPORT AT 1-877-287-8634

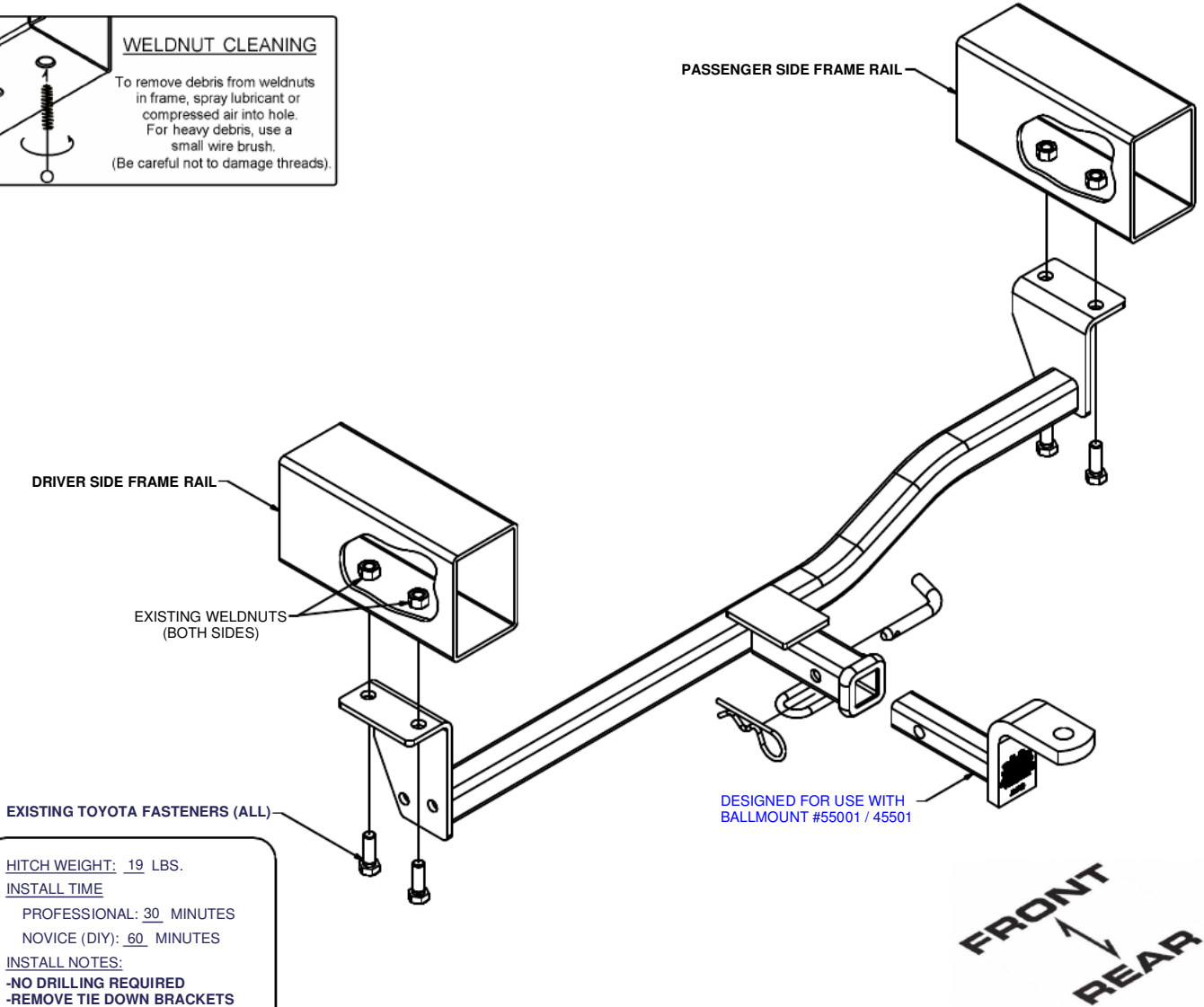
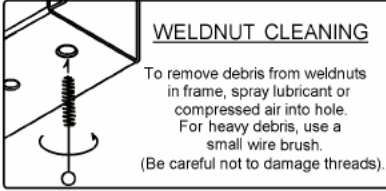

HITCH WEIGHT: 19 LBS.
INSTALL TIME
 PROFESSIONAL: 30 MINUTES
 NOVICE (DIY): 60 MINUTES
INSTALL NOTES:
 -NO DRILLING REQUIRED
 -REMOVE TIE DOWN BRACKETS

INSTALLATION STEPS

1. Locate the tie down brackets on the rear of the driver and passenger side frame rails near the bumper. Remove these brackets. Retain 12mm bolts and washers to install this hitch. Return tie down brackets to vehicle owner for reinstallation should the hitch ever be removed.
2. Raise the hitch onto position by passing the hitch cross tube over the exhaust tip(s) on the passenger side. Temporary removal of a center fascia retaining screw may allow easier placement of the hitch. The hitch end plates should line up with bolt holes where brackets were removed.
3. Fasten hitch with the 12mm bolts and washers removed from the tie down brackets in Step 1.
4. Torque all 12mm fasteners to 82 lb-ft.

PERIODICALLY CHECK THIS RECEIVER HITCH TO ENSURE THAT ALL FASTENERS ARE TIGHT AND THAT ALL STRUCTURAL COMPONENTS ARE SOUND.

Curt Manufacturing Inc., warrants this product to be free of defects in material and/or workmanship at the time of retail purchase by the original purchaser. If the product is found to be defective, Curt Manufacturing Inc., may repair or replace the product, at their option, when the product is returned, prepaid, with proof of purchase. Alteration to, misuse of, or improper installation of this product voids the warranty. Curt Manufacturing Inc.'s liability is limited to repair or replacement of products found to be defective, and specifically excludes liability for incidental or consequential loss or damage.