



300 HUEY LENARD LOOP | WEST MONROE | LA 71292
 OFFICE: 318-397-3000 | FAX: 318-397-3040
 SERVICE & TECH SUPPORT: 800-551-4955
 SUPERLIFT.COM



2004-2008 FORD F-150 PICKUP 4WD 4.5 & 6 Inch Lift Kits INSTALLATION INSTRUCTIONS

Engineered for 4WD Models ONLY.

Fits: 2004-2008 Ford F-150 4WD



⚠️ NOTE: Does NOT Fit 2004 Heritage Models.

🚫 CAUTION: MAKE SURE YOU HAVE THE CORRECT LIFT FOR YOUR VEHICLE:
 Double check the Year, Make, Model, Lift Height and KIT Part Numbers.

⚠️ NOTE: Prior to beginning the installation, OPEN the Boxes and CHECK the Included Components Compared to the Parts Breakdown. Check all parts and hardware in the box with the parts list below. Be sure you have all needed parts and know where they install.

IF you find a packaging error, contact SUPERLIFT directly. Do not contact the dealer where the system was originally purchased. You will need the control number from each box when calling; this number is located at the bottom of the part number label and to the right of the bar code.

- 1 Lift Block, Rear
- 2 9/16" U-Bolts, U-Bolt Nuts & Washers
- 3 Shock Absorbers, Rear
- 4 Crossmember, Rear
- 5 Strut Spacer, Front
- 6 Sway Bar Drop Brackets
- 7 Differential Drop Bracket, DR. & PA
- 8 Belly Pan
- 9 Replacement Strut, BILSTEIN
- 10 Knuckle, PA. Side
- 11 Crossmember, Front
- 12 Knuckle, DR. Side
- 13 Eccentric Cam Bolts
- 14 Brake Line Bracket, Rear
- 15 Brake Line Bracket, DR. & PA. Side
- 16 Hardware & Thread Locker
- 17 Vacuum Hose & Adapter

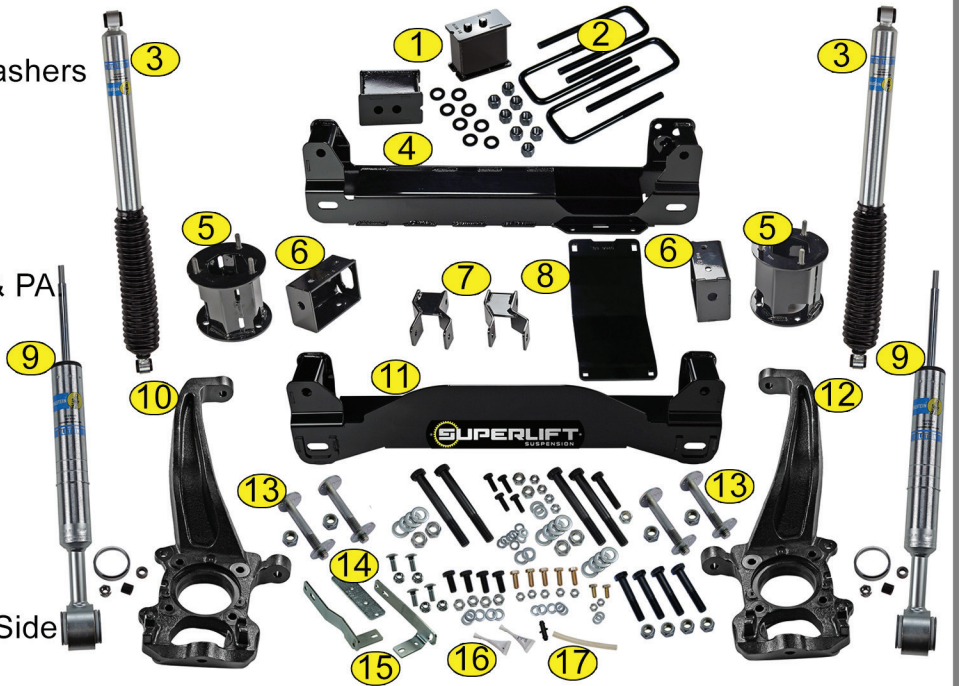

⚠️ NOTE: K173 Does Not Include Replacement BILSTEIN Front Struts

How to Read the Kit Breakdown Charts:

The 'K KIT BREAKDOWN' lists the Part Numbers, Quantities & Part Description of the Boxes that are included in the K KIT. The 'KIT BREAKDOWN' lists Part Numbers, Quantities & Part Description of the Individual Components & Hardware Bags that are included in Each Box. The 'HARDWARE BREAKDOWN' lists the Part Numbers, Quantities & Part Description of the Individual Components.

K KIT BREAKDOWN

Kit Part Number K173 4.5" Lift Kit with SUPERLIFT Shocks			Kit Part Number K174B 6" Lift Kit with BILSTEIN Shocks		
Part Number	Qty.	Part Description	Part Number	Qty.	Part Description
9940	1	kit box, knuckles	9940	1	kit box, knuckles
9941	1	kit box, differential & sway bar drop, brake line brkts	9941	1	kit box, differential & sway bar drop, brake line brkts
9942	1	kit box, rear crossmember and strut spacers	9942	1	kit box, rear crossmember and strut spacers
9943	1	kit box, front crossmember and belly pan	9943	1	kit box, front crossmember and belly pan
9944	1	kit box, rear blocks	9946	1	kit box, rear blocks
84057	1	kit box, rear shocks - Superide	84059	1	kit box, front strut and rear shocks - Bilstein

Kit Part Number K173B 4.5" Lift Kit with BILSTEIN Shocks		
Part Number	Qty.	Part Description
9940	1	kit box, knuckles
9941	1	kit box, differential & sway bar drop, brake line brkts
9942	1	kit box, rear crossmember and strut spacers
9943	1	kit box, front crossmember and belly pan
9944	1	kit box, rear blocks
84058	1	kit box, rear shocks - Bilstein

KIT BREAKDOWN

Kit Part Number 9940			Kit Part Number 9944		
Part Number	Qty.	Part Description	Part Number	Qty.	Part Description
66-01-9940	1	knuckle, driver side	55-30-9930	1	block, rear (4.5")
66-02-9940	1	knuckle, passenger side	10342	4	9/16" x 3-5/16" x 10" ubolt, square
77-9940	1	hardware bag, thread locker	77-1509	1	hardware bag, ubolt nuts and washers

Kit Part Number 9941			Kit Part Number 9946		
Part Number	Qty.	Part Description	Part Number	Qty.	Part Description
55-29-9940	1	differential drop, driver side	55-31-9930	1	block, rear (6")
55-30-9940	1	differential drop, passenger side	10362	4	9/16" x 3-5/16" x 12" ubolt, square
55-31-9940	1	sway bar drop, driver side	77-1509	1	hardware bag, ubolt nuts and washers
55-32-9940	1	sway bar drop, passenger side			
77-9941	1	hardware bag, nuts and bolts			
77-9941A	1	hardware bag, brake line brackets and vent hose			

Kit Part Number 9942			Kit Part Number 84057		
Part Number	Qty.	Part Description	Part Number	Qty.	Part Description
55-28-9940	1	crossmember, rear	01-85150 (650341)	2	shock cylinder, Superlift rear
55-34-9940	2	strut spacer (4.5")	77-87037	2	hardware bag, shocks bushings and sleeves
77-9942	1	hardware bag, nuts and bolts			
77-9942A	1	hardware bag, cam bolts and washers			

Kit Part Number 9943			Kit Part Number 84059		
Part Number	Qty.	Part Description	Part Number	Qty.	Part Description
55-27-9940	1	crossmember, front	BE5-C298-H0	2	replacement strut (6"), Bilstein
55-33-9940	1	belly pan	BE5-6249-H5	2	shock cylinder, Bilstein rear
77-9943	1	hardware bag, nuts and bolts	77-87037	2	hardware bag, shocks bushings and sleeves

HARDWARE BAG BREAKDOWN

Kit Part Number 77-9940			Kit Part Number 77-9942		
Part Number	Qty.	Part Description	Part Number	Qty.	Part Description
F470L	2	thread locker	18mx2.5x150cs	2	18mm x 150mm bolt, 2.5 pitch
			18mfw	4	18mm washer, flat

Kit Part Number 77-9941			Kit Part Number 77-9942A		
Part Number	Qty.	Part Description	Part Number	Qty.	Part Description
14c5nn	2	1/4" nut, nyloc	66-22-9940	4	18mm x 140mm cam bolt, cam washer & nyloc nut
14sw	2	1/4" washer, sae			
14x34c8cs	2	1/4" x 3/4" bolt, coarse thread			
12mnn	2	12mm nut, nyloc			
12mfw	4	12mm washer, flat			
12mx1.75x90cs10.9	2	12mm x 90mm bolt, 1.75 pitch			
10mnn	4	10mm nut, nyloc			
10mfw	8	10mm washer, flat			
10mx1.5x30csg10.9	4	10mm x 30mm, 1.5 pitch			
516c5nn	5	5/16" nut, nyloc			
516sw	5	5/16" washer, sae			
516x34c8cs	5	5/16" x 3/4" bolt, coarse thread			

Kit Part Number 77-9941A			Kit Part Number 77-1509		
Part Number	Qty.	Part Description	Part Number	Qty.	Part Description
21-3205	1	5/16" x 3-1/2" vacuum hose	1511-B09	8	9/16" high nut, fine thread
23-3205	1	5/16" hose adapter	1509	8	9/16" ubolt washer
55-36-9940	1	brake line bracket, front driver			
55-37-9940	1	brake line bracket, front passenger			
55-38-9940	1	brake line bracket, rear			

Kit Part Number 77-87037		
Part Number	Qty.	Part Description
01-60418	2	01-60418, hourglass bushing
24-5704	2	24-5704, 0.75" OD x 0.50" ID x 1.54" L, sleeve



300 HUEY LENARD LOOP | WEST MONROE | LA 71292
 OFFICE: 318-397-3000 | FAX: 318-397-3040
 SERVICE & TECH SUPPORT: 800-551-4955
 SUPERLIFT.COM



2004-2008 FORD F-150 PICKUP 4WD 4.5 & 6 Inch Lift Kits INSTALLATION INSTRUCTIONS

**THANK YOU FOR CHOOSING
 SUPERLIFT FOR ALL
 YOUR SUSPENSION NEEDS!**



⚠ CAUTION: Read And Understand All Instructions And Warnings Prior To Installation Of System AND Operation Of Vehicle.

INTRODUCTION BEFORE INSTALLATION...

Installation requires a professional mechanic. In addition to these instructions, professional knowledge of disassembly / reassembly procedures and post installation checks must be known.

PRIOR to beginning, inspect the vehicles steering, driveline, and brake systems, paying close attention to the suspension link arms and bushings, sway bars and bushings, tie rod ends, pitman arm, idler arm, ball joints and wheel bearings. Also check the steering sector-to-frame and all suspension-to-frame attaching points for stress cracks. The overall vehicle must be in excellent working condition; repair or replace all worn parts. Read instructions several times before starting.

Read each step completely as you go.

Be sure you have all needed parts and know where they install.

⚠ NOTES:

- Do NOT install this suspension system in conjunction with any other type of aftermarket or fabricated components to gain additional suspension height.
- Do not fabricate any components to gain additional suspension height.
- Prior to drilling or cutting, check behind the surface being worked on for any wires, lines, or hoses that could be damaged. Prep all cutting surfaces by removing all debris and frame coatings.
- After drilling, file smooth any burrs and sharp edges.
- Prior to operating a torch or saw, protect any heat-sensitive components located in the immediate area by covering them with a water-saturated cloth. Most undercoating are flammable but can be extinguished using a water-filled spray bottle. Have a spray bottle and an ABC rated fire extinguisher on hand.
- Paint or undercoat all exposed metal surfaces.
- Prior to attaching components, be sure all mating surfaces are free of grit, grime, grease, undercoating, etc.
- Front end alignment is necessary.
- Tool and Wrench/Socket size is given in brackets [] after each appropriate step.
- A foot-pound torque reading is given in parenthesis () after each appropriate fastener.
- Always wear safety glasses when using power tools.
- A factory service manual should be on hand for reference.

BEFORE YOU DRIVE...

Check all fasteners for proper torque. Check to ensure for adequate clearance between all rotating, mobile, fixed, and heated members. Verify clearance between exhaust and brake lines, fuel lines, fuel tank, floor boards and wiring harness. Check steering components for clearance.

Test and inspect brake system. Perform steering sweep to ensure front brake hoses have adequate slack and do not contact any rotating, mobile or heated members. Inspect rear brake hoses at full extension for adequate slack. Failure to perform hose check/replacement may result in component failure.

Perform head light check and adjustment.

⚠️ WARNING: It is the ultimate buyer's responsibility to have all bolts / nuts checked for tightness after the first 100 miles and then every 1000 miles. The steering, suspension and driveline systems, plus wheel alignment should be inspected by a qualified professional mechanic at least every 3000 miles.

TECH TIP / TIME SAVER...

- Some minor trimming will be required with certain wheel/ tire combination. This is normal with most aftermarket tire/wheel fitments on Ford F-150 trucks. Trimming will normally include the bottom edge of the inner fender shrouds and/or lower corner of front bumper valance. As a rule of thumb, deeper backspacing and shorter/ narrower tires will reduce/eliminate trimming required.

TIRES & WHEELS...

Larger rim and tire combinations may increase leverage on suspension, steering, and related components. When selecting combinations larger than OE, consider the additional stress you could be inducing on the OE and related components.

⚠️ NOTE: Stock \ Factory 17" Wheels on 2004-2008 Ford F-150 Models Will NOT Fit back on the vehicle once this suspension system is installed. Requires 18" or larger Diameter Wheels.

Recommended 18" wheel dimensions are 9.0" - 10" wide with 4.50" - 5.00" Backspacing.

🔧 TECH TIP Best Recommended Tire & Wheel Combination is a 35.00" x 12.50" Tire on an 18x9 or 20x9 with a 4.50" - 5.70" Back Spacing | [-12mm] to [+18mm] Offset.

⚠️ WARNING: ANY larger or wider tire & wheel combination other than listed Will Require Vehicle Trimming.

* Some Minor Trimming Maybe Required.

⚠️ NOTE: ALL Tire & Wheel Combinations Should Be Test Fit Prior to Installation.

IMPORTANT DISCLAIMER: The provided tire/wheel fitments are approximate. Actual dimensions of a given tire size can vary considerably from one brand to another. Manufacturers' wheel offset and backspacing measurement points are not always consistent. Backspacing greatly impacts tire-to-fender clearance when turning. Wheel width and backspacing influence whether the tires protrude past the fenders, and to what extent. Considering these important factors, we recommend that you fit-check your tire/wheel selection prior to purchasing.

TIRE SIZE SPECIFICATIONS			
Tire Size	Wheel	Back Spacing (INCH)	Offset (MM)
305/70 R18	18x9	4.50" - 5.70"	[-12mm] to [+18mm]
35x12.50 R18	18x9	4.50" - 5.70"	[-12mm] to [+18mm]
325/65 R18	18x9	4.50" - 5.70"	[-12mm] to [+18mm]
35x13.00 R18	18x9	4.50" - 5.70"	[-12mm] to [+18mm]
315/60 R20	20x9	4.50" - 5.70"	[-12mm] to [+18mm]
315/60 R20	20x10	4.50" - 5.00"	[-24mm] to [-12mm]
35x12.50 R20	20x9	4.50" - 5.70"	[-12mm] to [+18mm]
35x12.50 R20	20x10	4.50" - 5.00"	[-24mm] to [-12mm]
325/50 R22	22x9	4.50" - 5.70"	[-12mm] to [+18mm]
325/50 R22	22x10	4.50" - 5.00"	[-24mm] to [-12mm]
35x12.50 R22	22x9	4.50" - 5.70"	[-12mm] to [+18mm]
35x12.50 R22	22x10	4.50" - 5.00"	[-24mm] to [-12mm]

Step	Part Number	Qty. Per Kit	Description	New Attaching Hardware	Qty. Per Bracket	Hardware Bag Number
16	55-29-9940	1	differential drop, driver side	12mm x 90mm bolt, 1.75 pitch	1	77-9941
				12mm washer, flat	2	
				12mm nut, nyloc	1	
16	55-30-9940	1	differential drop, passenger side	12mm x 90mm bolt, 1.75 pitch	1	77-9941
				12mm washer, flat	2	
				12mm nut, nyloc	1	
17	21-3205	1	5/16" x 3-1/2" vacuum hose			77-9941A
	23-3205	1	5/16" hose adapter			
18	55-31-9940	1	sway bar drop, driver side	10mm x 30mm, 1.5 pitch	2	77-9941
				10mm washer, flat	4	
				10mm nut, nyloc	2	
18	55-32-9940	1	sway bar drop, passenger side	10mm x 30mm, 1.5 pitch	2	77-9941
				10mm washer, flat	4	
				10mm nut, nyloc	2	
18	55-28-9940	1	crossmember, rear	18mm x 150mm bolt, 2.5 pitch	2	77-9942
				18mm washer, flat	4	
				18mm nut, nyloc	2	77-9942A
				66-22-9940 cam bolt assembly	2	
				12mm x 90mm bolt, 1.75 pitch	1	
				12mm washer, flat	2	
12mm nut, nyloc	1					
20	55-27-9940	1	crossmember, front	18mm x 140mm bolt, 2.5 pitch	2	77-9942
				18mm washer, flat	4	
				18mm nut, nyloc	2	77-9942A
				66-22-9940 cam bolt assembly	2	
21	55-33-9940	1	belly pan	3/8" x 1" carriage bolt, coarse thread	4	77-9943
				3/8" flange nut	4	
25	55-34-9940	2	strut spacer (4.5")	10mm flange nut	3	77-9942
26	24-239363	2	replacement strut (6"), Bilstein front			
27	66-01-9940	1	knuckle, driver side	F470L, thread locker	1	77-9940
27	66-02-9940	1	knuckle, passenger side	F470L, thread locker	1	77-9940
33	55-36-9940	1	brake line bracket, front driver side	5/16" x 3/4" bolt, coarse thread	2	77-9941
				5/16" nut, nyloc	2	
				5/16" washer, sae	2	
				1/4" x 3/4" bolt, coarse thread	1	
				1/4" washer, sae	1	
				1/4" nut, nyloc	1	
33	55-37-9940	1	brake line bracket, front passenger side	5/16" x 3/4" bolt, coarse thread	2	77-9941
				5/16" nut, nyloc	2	
				5/16" washer, sae	2	
				1/4" x 3/4" bolt, coarse thread	1	
				1/4" washer, sae	1	
				1/4" nut, nyloc	1	
47	55-31-9930	2	block, rear (6")	10362 - 9/16" x 3-5/16" x 12" ubolt, square	2	77-1509
				9/16" high nut, fine thread	4	
				9/16" ubolt washer	4	
47	55-30-9930	2	block, rear (4.5")	10342 - 9/16" x 3-5/16" x 10" ubolt, square	2	77-1509
				9/16" high nut, fine thread	4	
				9/16" ubolt washer	4	
48	01-85150 (650341)	2	shock cylinder, Supelift rear	01-60418, hourglass bushing	2	77-87037
				24-5704, 0.75" OD x 0.50" ID x 1.54" L, sleeve	2	
48	33-185569	2	shock cylinder, Bilstein rear			
49	55-38-9940	1	brake line bracket, rear	5/16" x 3/4" bolt, coarse thread	1	77-9941
				5/16" nut, nyloc	1	
				5/16" washer, sae	1	

TOOLS & TECH...

This is a list of tools needed to install this lift kit. Double check the list to make sure that you have all the tools and equipment required to accomplish the complete install.

We have also included a **Tech Tip** noted by this icon

 **TECH TIP** to help if we have found a quicker or easier way to accomplish a task in the steps.

TOOLS		
Miscellaneous Tools	Wrench / Socket Sizes	
	Standard	Metric
Floor Jack		
Jack Stands	3/8"	8mm
Flathead Screwdriver	7/16"	10mm
Hammer	1/2"	12mm 12Pt
Plastic Fastener Removal Tool	9/16"	13mm
Die Grinder with Cut-Off Wheel	5/8"	15mm
Torque Wrench	3/4"	16mm
Drill	13/16"	18mm
Drill Bit: 9/16"	7/8"	19mm
9/16" Transfer Punch		21mm
		27mm
		30mm
		8mm Allen
		5mm Allen

NOTE: Use the check-off box found at each step to help you keep your place. Two denotes that one check-off box is for the Driver Side (Left) and one is for the Passenger Side (Right). Unless otherwise noted, always start with the Driver Side.

FRONT DISASSEMBLY

NOTE: Save ALL factory components and hardware for reuse, unless noted.

1) PREPARE VEHICLE FOR FRONT...

Chock rear tires and place transmission in neutral. Raise front of vehicle with a jack and secure a jack stand beneath each frame rail. Ease the frame down onto the stands and place transmission in park. Remove front tires. [Lug Nuts 21mm]

Disconnect the battery.

NOTE: Perform Steps 2 -7 One Side at a Time.

2) STEERING TIE ROD END...

[Illustration 1] Remove the tie rod retaining nut. [21mm] Reinstall the nut a couple of turns by hand.

Use a Tie Rod Puller to separate the tie rod from the knuckle.

 **TECH TIP** If you do not have a puller, you can use the method of striking the knuckle near the ball joint end to dislodge the knuckle. Strike the knuckle portion only.

Remove the tie rod nut and save for re-install. Push the linkage forward until out of the way.

[Illustration 1]



3) BRAKE**CALIPER...**

☐☐ [Illustration 2]

Unbolt the brake caliper by removing the two (2) factory bolts [18mm]. Remove caliper from the rotor. Secure or hang the caliper to the framer away from the work area.

⚠NOTE: Do not let calipers hang from brake lines.

☐☐ Remove the brake rotor from the axle.

4) AXLE NUT...

☐☐ [Illustration 3]

Remove the dust cap from the center over the CV axle nut. [flat screwdriver] Remove the CV axle nut [13mm]

5) HUB VENT TUBES...

☐☐ [Illustration 4] Located on the back side of the knuckle, disconnect the two (2) vent tubes from the hub assembly. [flat screwdriver]

6) ABS SENSOR...

☐☐ [Illustration

5] Located on the rearward side of the knuckle, unbolt and remove the ABS sensor from the hub assembly. [5mm allen]

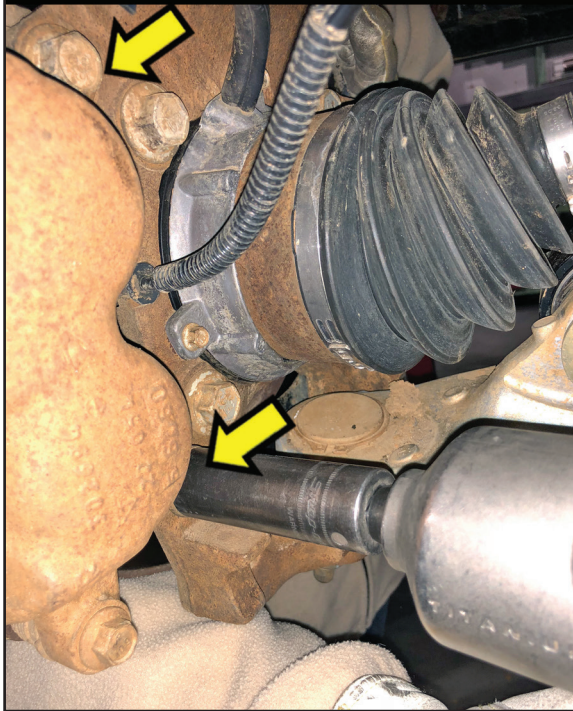
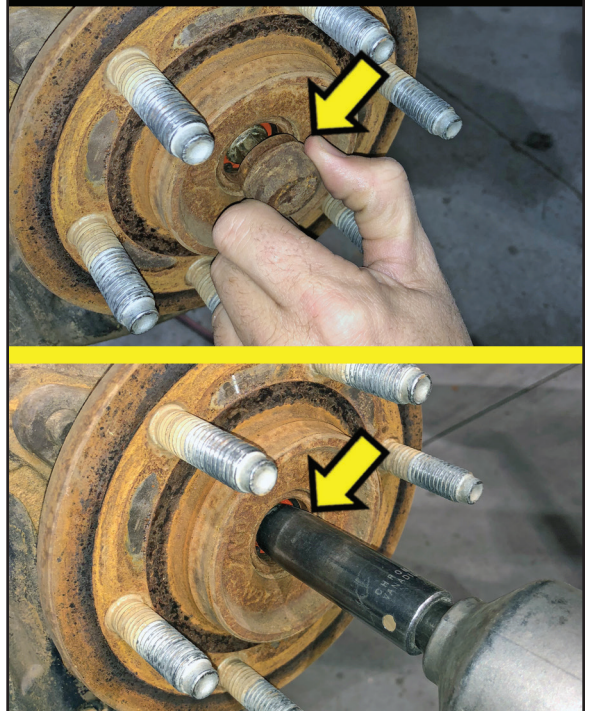
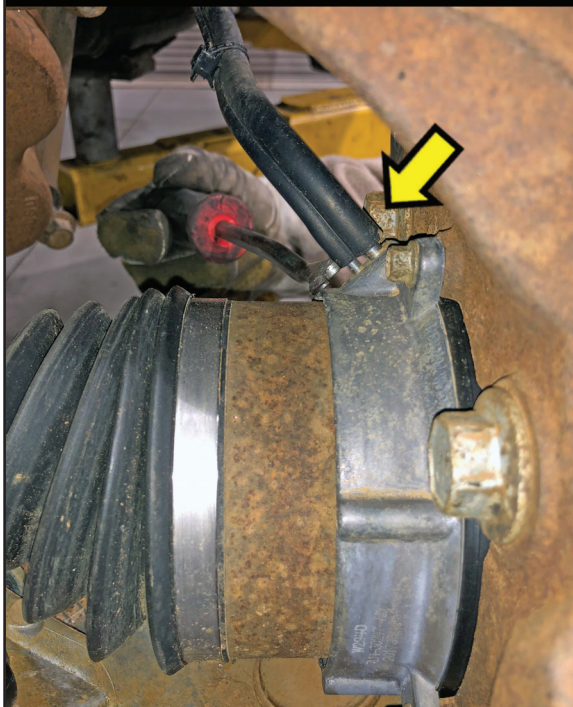
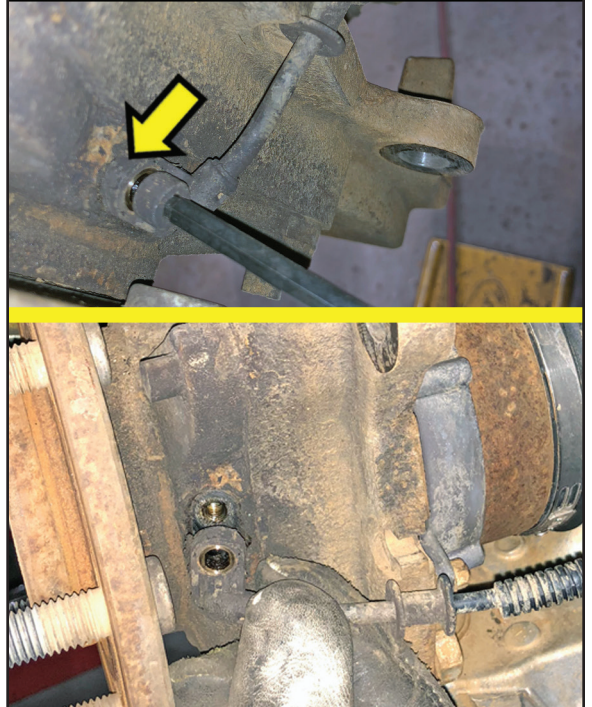
[Illustration 2]**Disconnect Brake Caliper...
Driver Side****[Illustration 3]****Remove Axle Nut...
Driver Side****[Illustration 4]****Disconnect the Vent Tubes...
Driver Side****[Illustration 5]****Disconnect the ABS Sensor...
Driver Side**

7) KNUCKLE...

Using a jack, slightly lift the Lower Control Arm (LCA) & knuckle assembly to prevent the arms from being at full droop.

☐☐ [Illustrations 6] Remove the nut from the Upper Ball Joint (UBJ) [21mm], then using the appropriate puller tool, disconnect the ball joints from the knuckle. **TECH TIP** If you do not have a puller tool, you can use a hammer by very carefully striking the ball joint boss of the knuckle; do not strike the ball joints.

WARNING: Be careful. Do not let the CV axle shaft dislodge from the CV cup or 'pull out' at the differential.

WARNING: Be careful. Do not let the knuckle fall to the side abruptly. It could cause damage to the ABS wires or brake lines.

Lower the jack to allow the removal of the knuckle assembly from the UBJ, but keep the jack in place. Secure the knuckle forward to allow access to the Lower Ball Joint (LBJ) & lower strut mount.

☐☐ [Illustrations 7] Remove the nut from the Lower Ball Joint (LBJ) [24mm]

☐☐ [Illustrations 8] Remove knuckle from vehicle.

TECH TIP When you remove a factory nut or bolt, like the upper and lower ball joint nuts, put it back into the factory spot for safe keeping. You will not have to look or sort through removed hardware to find the proper nut. Same with sway bar bushings & nut, etc.

[Illustration 6]**Disconnect the UBJ...
Driver Side****[Illustration 7]****Disconnect the LBJ...
Driver Side****[Illustration 8]****Remove Knuckle...
Driver Side**

8) SWAY BAR LINKS...

□□ [Illustration 9] On each side, loosen and remove the bushings and hardware attaching the sway bar link to the lower control arm and the sway bar body. [15mm]

[Illustration 9]

Disconnect Sway Bar Links... Driver Side



[Illustration 10]

Disconnect Lower Strut Mount... Driver Side

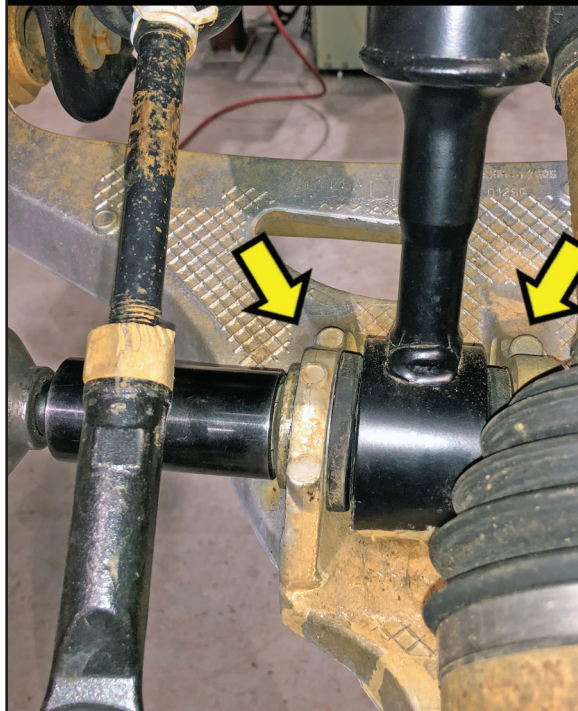

9) STRUT REMOVAL...

□□ [Illustration 10] Remove the two (2) bolts securing the strut to the lower control arm; allow the lower control arm to hang, while you move to the upper strut mount. [bolt: 27mm | nut: 30mm]

⚠WARNING: Be careful. Do not let the lower control arm fall abruptly.

⚠NOTE: Before you completely remove the strut, 'Mark' the Alignment of the Coil, Top Mount & Isolator. Also Mark 'DR.' & 'PA.' Side.

□□ [Illustration 11] Remove three (3) nuts securing the strut to the frame, then remove the strut. [15mm]

[Illustration 11]

Disconnect Upper Strut Mount... Driver Side

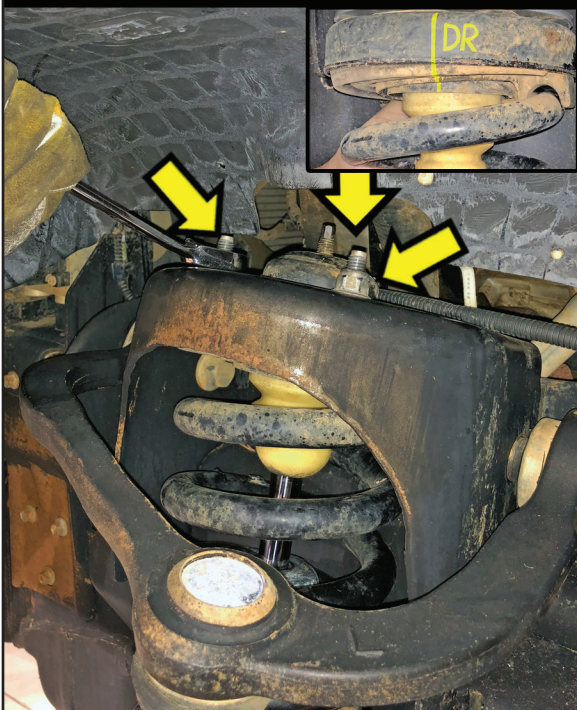

[Illustration 12]

Remove Lower Control Arm... Driver Side, Front Mount

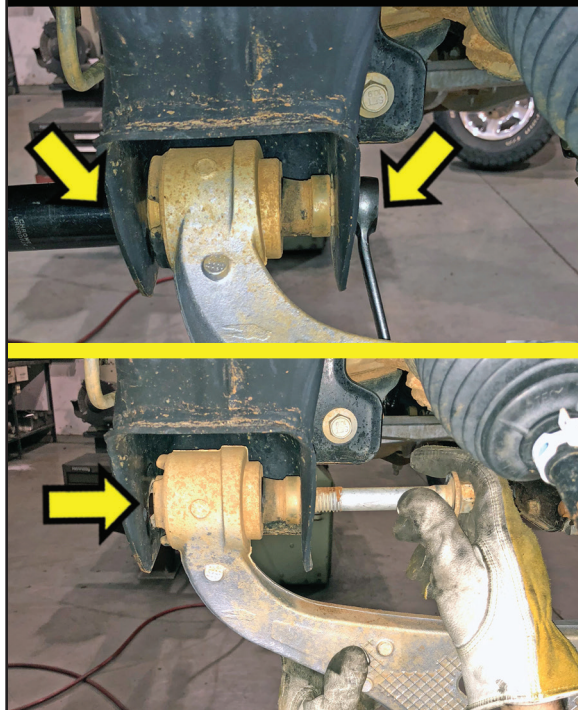

10) LOWER CONTROL ARM...

□□ [Illustration 12] Unbolt the Lower Control Arm (LCA) front mount from the front crossmember. [bolt: 21mm | nut: 27mm]

□□ Unbolt the Lower Control Arm (LCA) rear mount from the rear crossmember. [bolt: 21mm | nut: 27mm] Remove LCA.

⚠NOTE: Repeat Steps 8 - 10 On the Opposite Side.

11) SWAY BAR...

⚠ NOTE: Note the orientation of the sway bar for reference during reassembly. Mark DR & PA.

☐☐ [Illustration 13] Remove the two (2) nuts per side from the mount securing the sway bar to the frame. Retain factory hardware. [15mm] Remove the sway bar bushing mount and sway bar.

12) REAR CROSSMEMBER...

☐ [Illustration 14] Remove the four (4) bolts securing the rear crossmember from the frame. Two (2) Per Side. [bolt: 15mm | nut: 18mm] Discard crossmember.

13) DRIVESHAFT...

☐ [Illustration 15] Mark the orientation of the driveshaft for reference during reassembly. Remove the four (4) bolts securing the out of the way. [12mm 12 Point]

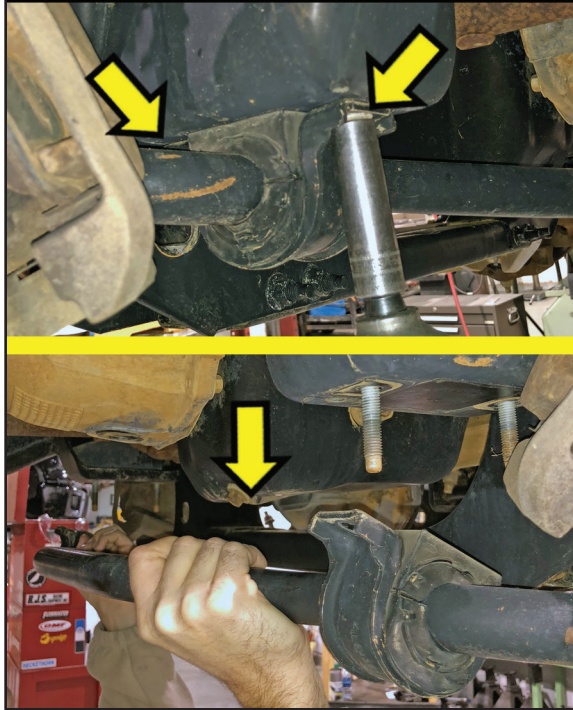
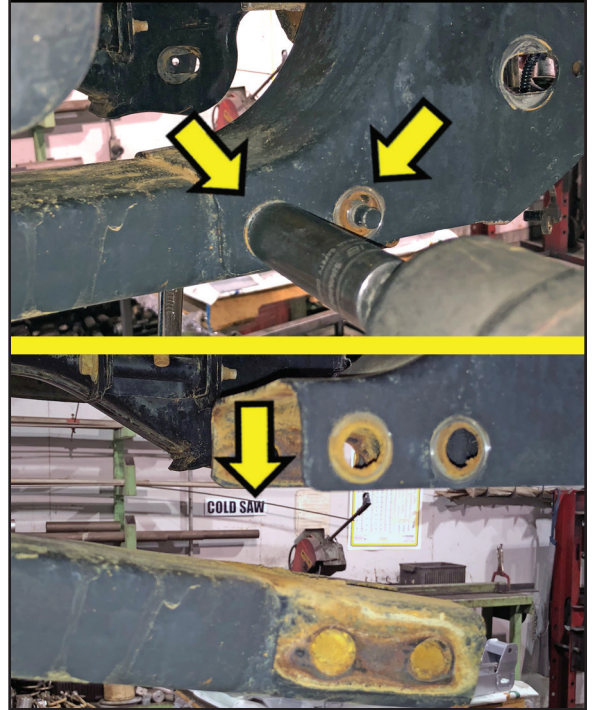
[Illustration 13]**Remove Sway Bar...
Driver Side****[Illustration 14]****Remove Rear Crossmember...
Passenger Side****[Illustration 15]****Remove Driveshaft...
Driver Side**

14) DIFFERENTIAL REMOVAL...

☐ Support the differential housing with a jack.

☐ [Illustration 16] Locate & disconnect the vent tube from the top of the differential.

☐ [Illustration 17] On the driver side, remove the upper differential bolt. [15mm] Retain for reuse.

⚠ NOTE: It may be necessary to turn the steering wheel slightly to allow the bolt to clear the steering assembly.

☐ [Illustration 18] On the driver side, remove the lower differential bolt. [15mm] Retain for reuse.

☐ [Illustration 19] On the passenger side, remove the differential bolt. [15mm] Retain for reuse.

Carefully lower the differential housing to the floor.

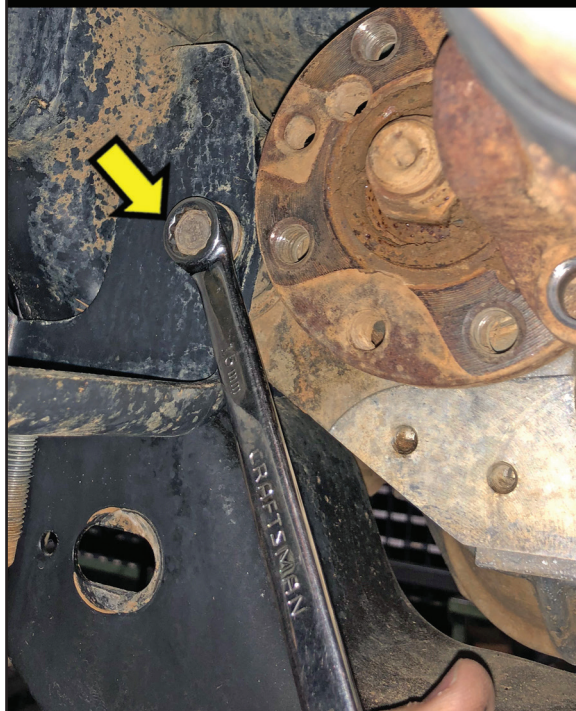
[Illustration 16]**Disconnect Vent Tube...
Driver Side****[Illustration 17]****Upper Differential Bolt...
Driver Side****[Illustration 18]****Lower Differential Bolt...
Driver Side****[Illustration 19]****Differential Bolt...
Passenger Side**

FRONT ASSEMBLY

15) TRIMMING THE FRAME...

⚠ NOTE: The following trimming is performed on the DRIVER ONLY.

□ [Illustration 20] On the driver side rear lower control arm mount, measure over from the inside edge of the crossmember mount to the outside 4-3/4 Inches. Mark the cut line all the way around the mount. Using a torch, plasma cutter, or similar tool, trim the driver side lower control arm bracket.

🚫 CAUTION:

When using a torch or plasma cutter, beware of the sticky, waxy undercoating - cosmoline. This will melt and drip during the cutting process. Take precautions to cover your person and the floor from this extremely HOT material.

□ [Illustration 21] On the driver side, the front lip of the rear lower control arm mount has a curved lip that has to be trimmed. Mark the cut line where the lip starts on the outside of the bracket parallel with the bottom of the bracket (approximately 1 Inch up from the bottom). Using a torch, plasma cutter, or similar tool, trim this area.

□ [Illustration 22] On the driver side, the top of the rear lower control arm mount has to be trimmed. Measure from the top outside edge in toward the frame 5/8 Inch. Mark the line parallel with the outer edge. Draw a line out from your mark to the outer edge at each corner curve. Using a torch, plasma cutter, or similar tool, trim this area.

[Illustration 20]

Trim Inside LCA Mount... Driver Side

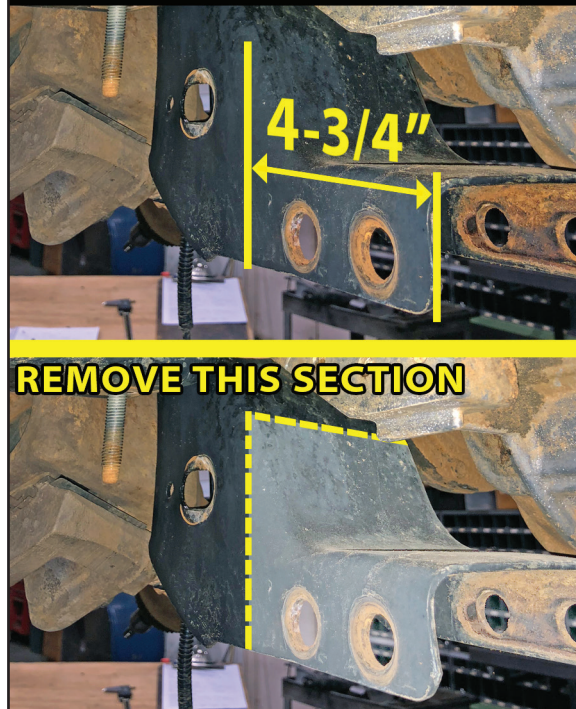

[Illustration 21]

Trim Rear LCA Mount Lip... Driver Side

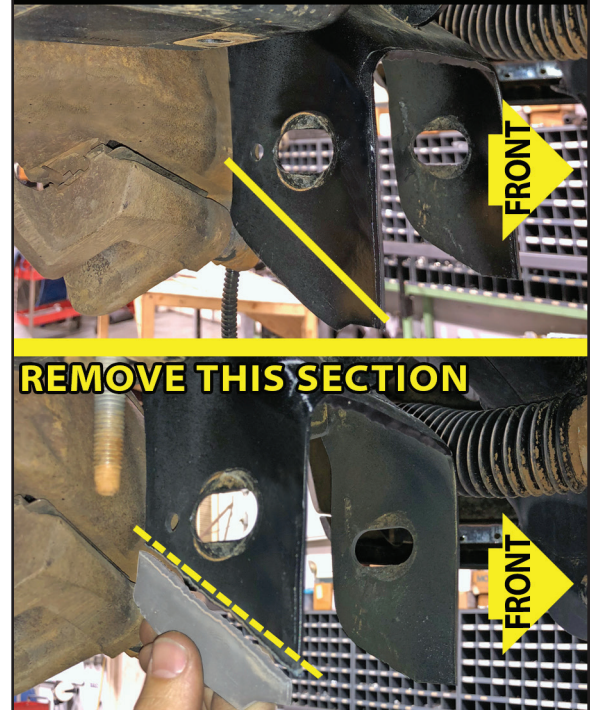

[Illustration 22]

Trim Top of LCA Mount... Driver Side



□ [Illustration 23]
On the driver side, the front flange of the rear lower control arm mount has to be trimmed. Measure from the bottom of the flange up towards the frame 2 Inches. Measure from the bottom of the flange over 1.50 Inches. Draw a line connecting these two marks. Using a torch, plasma cutter, or similar tool, trim this area.

□ Once you are happy with the cuts, deburr the edges with a grinder and apply a coat of paint or undercoating to prevent rust.

□ Locate the SUPERLIFT sway bar drop, driver side (#55-31-9940) & crossmember, rear (#55-28-9940) Locate Hardware Bag #77-9941 & Bag #77-9942.

□ [Illustration 24]
Temporarily install the driver side sway bar drop bracket (#55-31-9940) to the frame mount using the factory hardware. Note that the closed side goes to the outside & the open side goes to the inside. Install the rear crossmember (#55-28-9940) using two (2) 18mm x 150mm bolt, 2.5 pitch bolts. Install bolts front to rear. [27mm]

TECH TIP The offset of the crossmember goes toward the Front of the vehicle. Install the

[Illustration 23]

Trim Front of LCA Mount... Driver Side



[Illustration 24]

Position Brackets... Driver Side

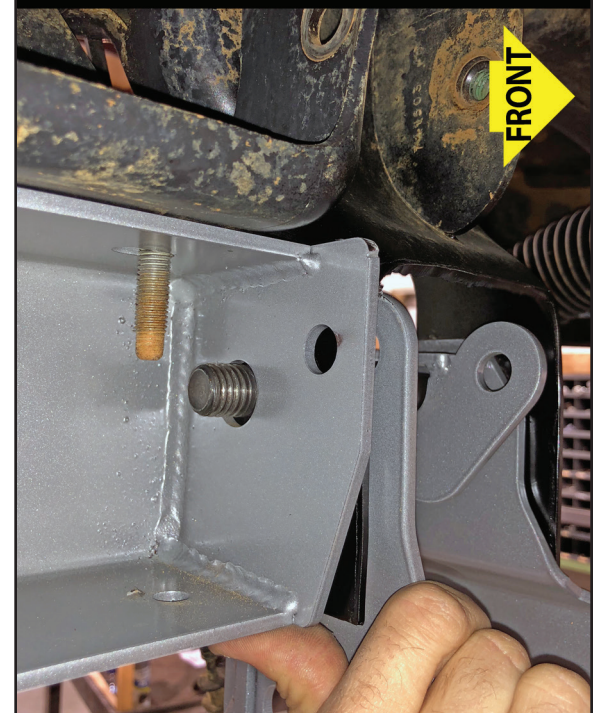

[Illustration 25]

Mark Hole Position... Driver Side

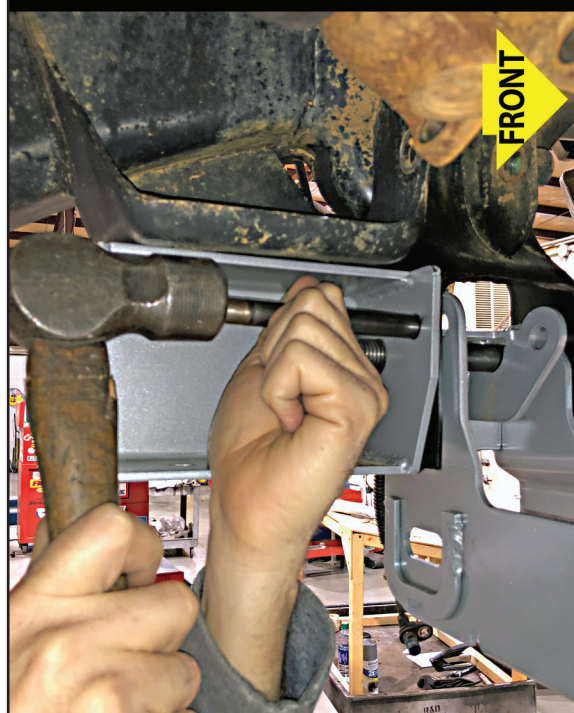

[Illustration 26]

Drill Hole Position... Driver Side

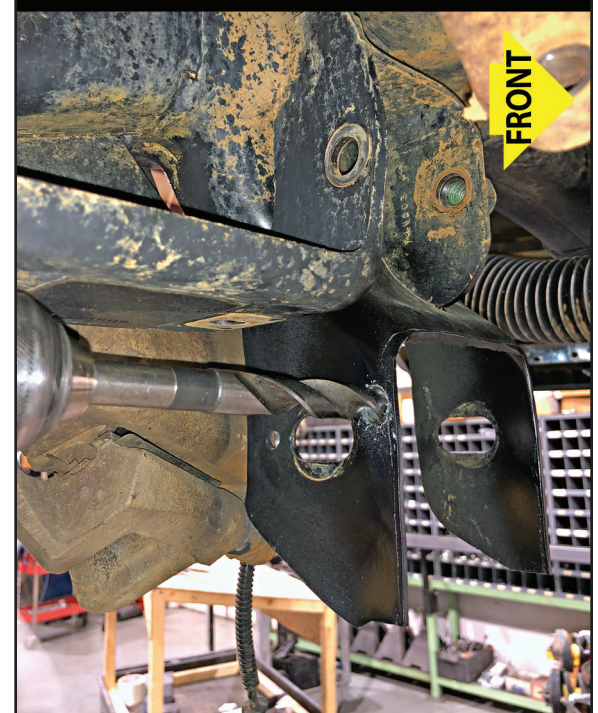

passenger side mount of the crossmember and bolt first, then swing the driver side up and into the factory mount.

□ [Illustration 25] Using a transfer hole punch, mark the hole position hole for the new differential bracket through the sway bar bracket.

□ [Illustration 26] Remove the sway bar bracket and rear crossmember. Drill a 9/16" hole.

16) DIFFERENTIAL BRACKETS...

Locate the SUPERLIFT differential drop bracket, driver side (#55-29-9940) & the differential drop bracket, passenger side (#55-30-9940).

Locate Hardware Bag #77-9941. Hardware PER Side: (1) 12mm x 90mm bolt, 1.75 pitch, 12mm flat washer & (1) 12mm Nyloc nut.

□ [Illustration 27] Attach the passenger side (#55-30-9940) bracket to the factory mount using the factory bolts. The

offset bend goes toward the Front of the vehicle. Run the bolt from front-to-rear. Do not tighten at this time. [15mm]

□ [Illustration 28] Attach the driver side (#55-29-9940) bracket to the factory mount using the factory bolts. The offset bend goes toward the Front of the vehicle. Run the bolt from front-to-rear. Do not tighten at this time. [15mm]

Using a jack, raise the differential into position and line up the mounting holes with the new differential drop brackets. Attach the differential on the driver side using the supplied 12mm x 90mm bolt, 12mm flat washer and 12mm Nyloc nut. Insert a washer onto the bolt, run the bolt from rear-to-front through the bracket and mount. Attach with washer and Nyloc nut. Do not tighten at this time. [19mm]

□ [Illustration 29] Attach the differential on the passenger side using the supplied 12mm x 90mm bolt and 12mm Nyloc nut. Insert a washer onto the bolt, run the bolt from front-to-rear through the bracket and mount. Attach with washer and Nyloc nut. Do not tighten at this time. [19mm]

[Illustration 27]

Passenger Side Diff Bracket... Passenger Side



[Illustration 28]

Driver Side Diff Bracket... Driver Side

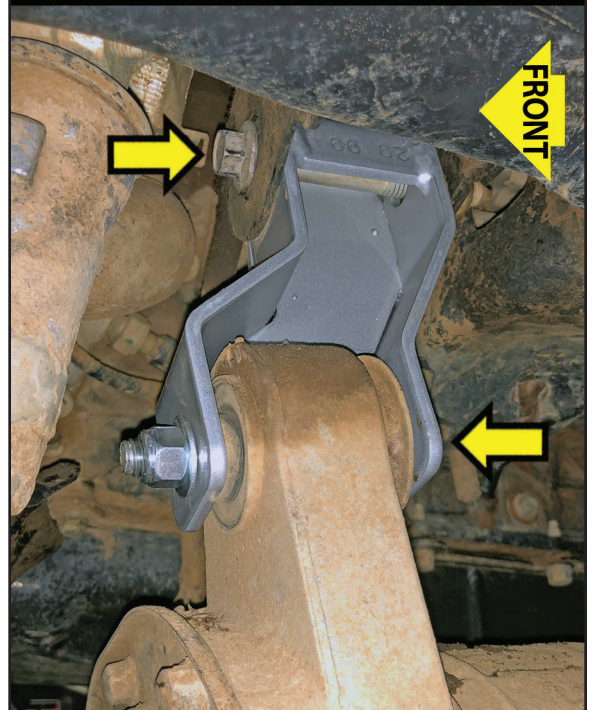

[Illustration 29]

Passenger Side Diff Bracket... Passenger Side

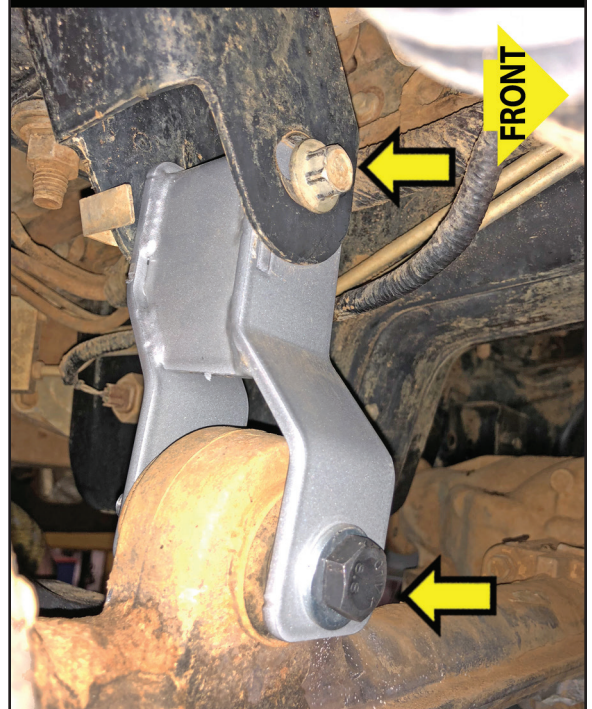

17) DIFFERENTIAL VENT TUBE...

Locate Hardware Bag #77-9941A. Hardware: (1) 5/16" hose adapter & (1) 5/16" x 3-1/2" vacuum hose

☐ [Illustration 30] Attach the supplied vent hose adapter to the factory vent hose. Attach the supplied vacuum hose to the adapter and reconnect the vent hose to the top of the differential.

18) REAR CROSSMEMBER & SWAY BAR BRACKETS...

☐☐ Locate the SUPERLIFT sway bar drop, driver side (#55-31-9940), sway bar drop, passenger side (#55-32-9940) & crossmember, rear (#55-28-9940)

Locate Hardware Bag #77-9941 & Bag #77-9942.

Hardware PER Side: Sway bar: (2) 10mm x 30mm, 1.5 pitch, (4) 10mm washers, flat & (2) 10mm Nyloc nuts. Hardware PER Side: Crossmember: (1) 18mm x 150mm bolt, 2.5 pitch, (2) 18mm washer, flat & (1) 18mm Nyloc nut.

Hardware PER Side: Rear differential mount: (1) 12mm x 90mm bolt, 1.75 pitch, (2) 12mm washer, flat & (1) 12mm Nyloc nut.

☐☐ [Illustration 31] Install the driver side sway bar drop bracket (#55-31-9940) to the frame mount using the supplied (2) 10mm x 30mm, (4) 10mm flat washers & (2) 10mm Nyloc nuts. Insert a washer onto the bolt, run the bolt down through the frame and through the bracket. Attach with washer and Nyloc nut to each bolt. Tighten. [16mm]

☐ Install the passenger side sway bar bracket in the same sequence. Tighten. [16mm]

☐ Install the rear crossmember (#55-28-9940) using the supplied (2) 18mm x 150mm bolts, (4) 18mm flat washers & (2) 18mm Nyloc nuts. Insert a washer onto the bolt, run the bolt from rear-to-front through the sway bar bracket, frame mount, through the crossmember and frame mount. Attach with washer and Nyloc nut. Do not tighten at this time. [27mm]

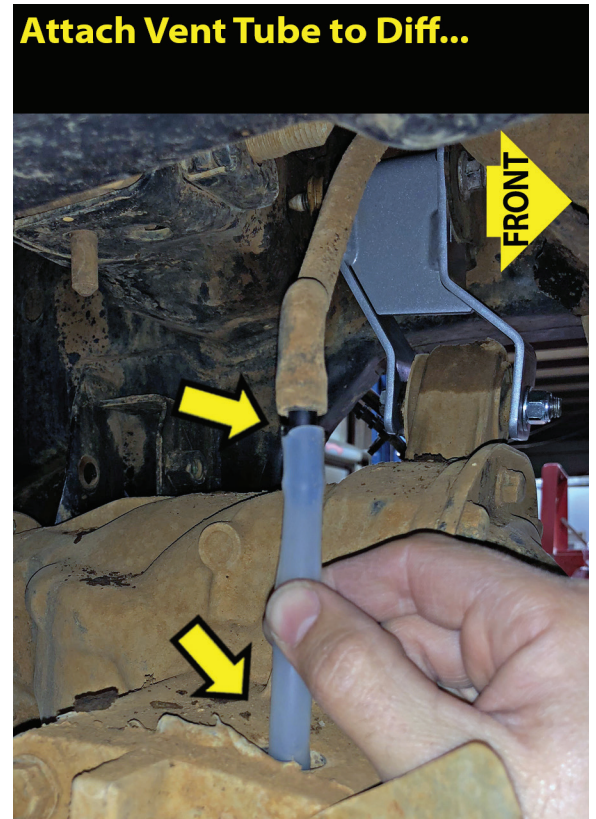
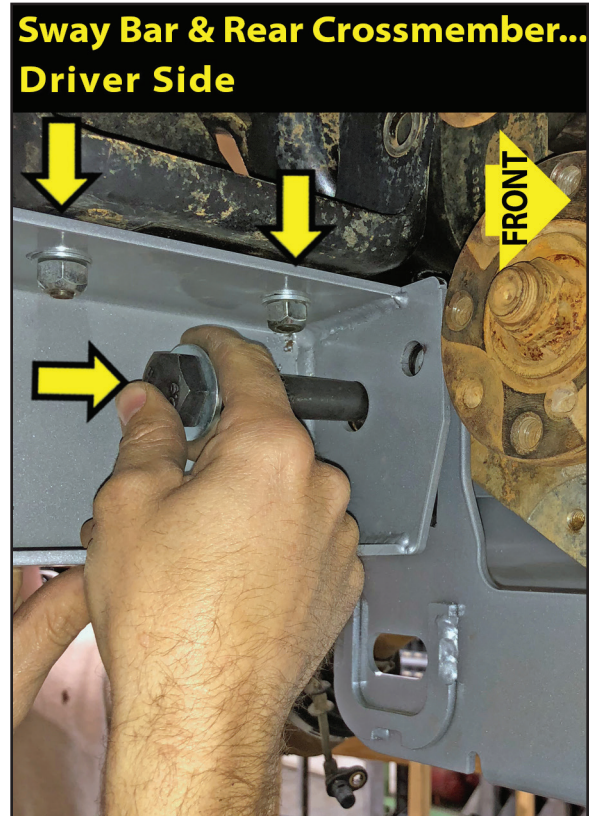
[Illustration 30]**Attach Vent Tube to Diff...****[Illustration 31]****Sway Bar & Rear Crossmember... Driver Side**

19) DIFFERENTIAL REAR MOUNT...

☐ [Illustration 32]

Attach the rear differential mount to the sway bar bracket and crossmember through the hole you drilled. Use a jack to raise the rear differential mount into place in the crossmember. Use the supplied (1) 12mm x 90mm bolt, (2) 12mm flat washers & (1) 12mm Nyloc nut. Insert washer onto the bolt, run the bolt from rear-to-front through the sway bar bracket, frame mount, through the factory rear differential mount and crossmember. Attach with washer and Nyloc nut. Do not tighten at this time. [19mm]

[Illustration 32]

Differential Rear Mount... Driver Side

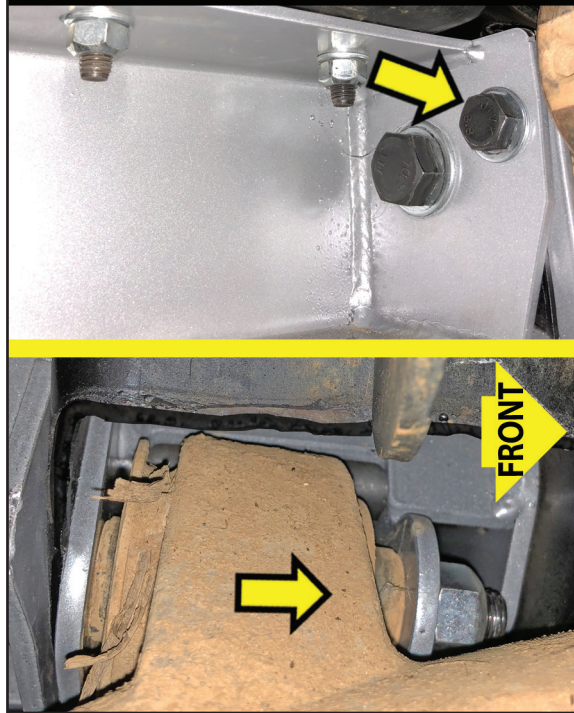

[Illustration 33]

Front Crossmember... Driver Side

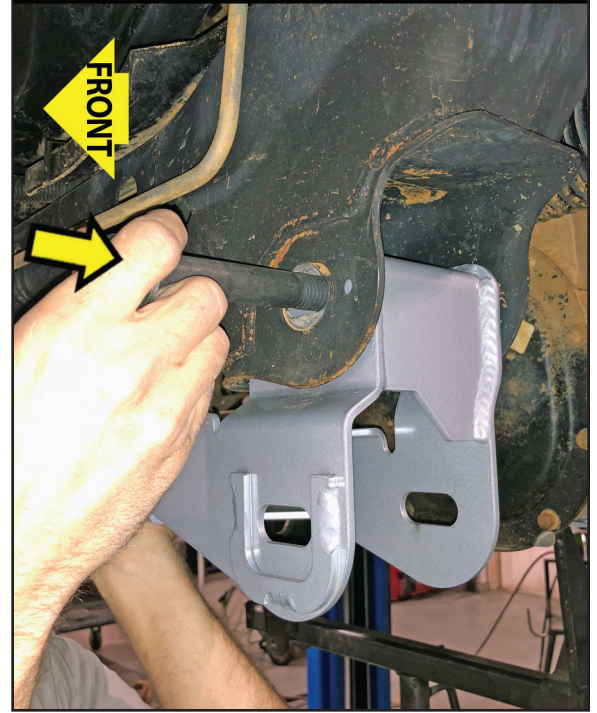

20) FRONT CROSSMEMBER...

Locate the SUPERLIFT front crossmember (#55-27-9940).

Locate Hardware Bag #77-9942. Hardware PER Side: (1) 18mm x 140mm bolt, 2.5 pitch, (2) 18mm washer, flats & (1) 18mm Nyloc nut.

☐☐ [Illustration 33] Attach the front crossmember (55-27-9940) to the lower control arm frame mounts using the supplied (1) 18mm x 140mm bolts, 18mm flat washers, and Nyloc nuts. The bolts should be installed from the front-to-rear.

TECH TIP The offset of the crossmember & the flat badge plate goes toward the Front of the vehicle. Install the passenger side mount of the crossmember and bolt first, then swing the driver side up and into the factory mount.

Do not tighten at this time. [27mm]

21) BELLY PAN...

Locate the SUPERLIFT front crossmember (#55-33-9940). Locate Hardware Bag #77-9943. Hardware PER Side: (4) 3/8" x 1" carriage bolt, coarse thread & (4) 3/8" flange nut.

☐ [Illustration 34] Attach the belly pan (#55-33-9940) to the mounting tabs on the front and rear crossmembers using the supplied 3/8" x 1" carriage bolts and flange nuts. Insert the carriage bolt up from the bottom of the belly pan and attach the flange nuts. [9/16"] Snug, but do not tighten.

[Illustration 34]

Install Belly Pan... Driver Side

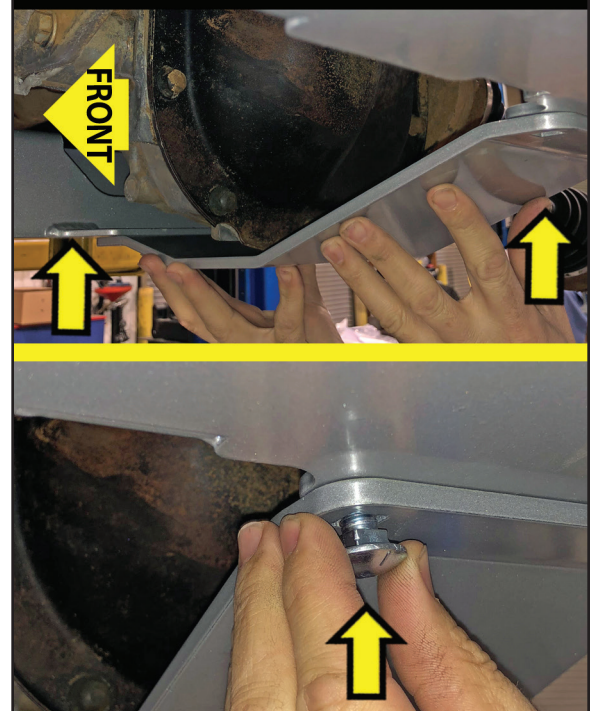

22) LOWER CONTROL ARMS...

Locate Hardware Bag #66-22-9940. Hardware PER Side: (2) 18mm x 140mm cam bolt, cam washer & Nyloc nut.

[Illustration 35] Install the factory lower control arms into the new crossmembers with the supplied alignment cam bolts and nuts. Insert the front cam bolt mount going front-to-rear. Insert the rear cam bolt from rear-to-front. **⚠ NOTE:** Make sure the cam washers fit between the control tabs on the crossmembers. The cam washer should be in the up or neutral position.

Snug, but do not tighten. [bolt 27mm, nut 27mm]

23) TIGHTEN THESE FASTENERS...

Tighten the following hardware in this order sequence. Refer back to the illustrations listed if needed.

- Rear crossmember mounting bolts to frame. [27mm] (280)
- Front crossmember to frame [bolt 21mm, nut 27mm] (280)
- Rear differential mounting bolt to rear crossmember. [19mm] (105)
- Driver differential bracket to frame. [15mm] (130)
- Passenger differential bracket to frame. [15mm] (130)
- Driver differential bracket to differential. [15mm] (130)
- Passenger differential brackets to differential. [15mm] (130)
- Sway bar drop brackets to frame. [17mm]
- Belly pan to front & rear crossmember. [9/16"] (30)

24) DRIVESHAFT...

Locate Hardware Bag #77-9940. Hardware: #F470L thread locker

[Illustration 36] Apply thread locker to the factory hardware, then line up the front driveshaft with the differential yoke according to the marks made during removal and secure using the factory hardware. Tighten [12mm] (19)

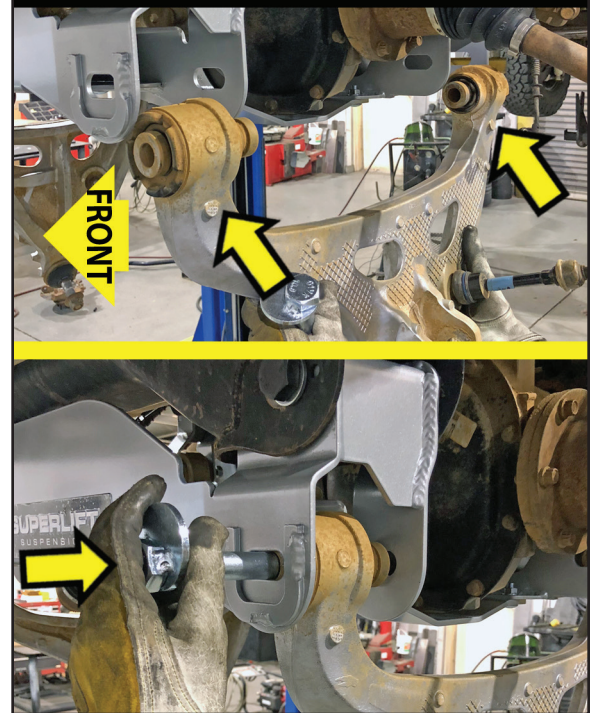
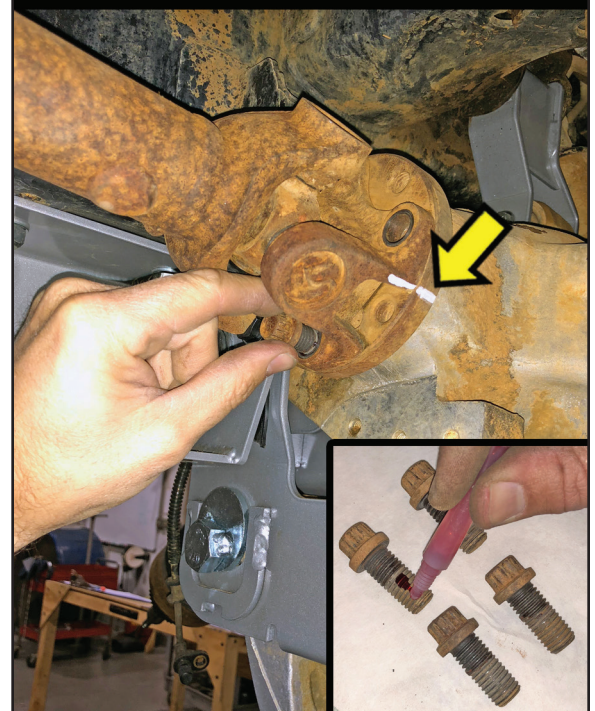
[Illustration 35]**Install Lower Control Arm...
Driver Side****[Illustration 36]****Reattach Front Driveshaft...
Driver Side**

⚠ NOTE: IF installing the 4.5" or 6" Lift WITH BILSTEIN STRUTS, Proceed to Step 26.

25) STRUT SPACER WITH FACTORY STRUT...

Locate the SUPERLIFT **[Illustration 37]**

(2) strut spacers (#55-34-9940). Locate Hardware Bag #77-9942. Hardware PER Side: (3) 10mm flange nuts.

□□ **[Illustration 37]** Attach the new strut spacer (55-34-9940) to the top of the strut assembly using the factory hardware and tighten the factory nuts. [15mm] (37)

□□ **[Illustration 38]** Slide the strut assembly through the upper control arm and locate the upper end of the assembly into the frame mount properly. Secure the upper end of the assembly using the supplied 10mm flange nuts. Snug, but do not tighten. [15mm] **TECH TIP** The strut assembly will only fit one way. Rotate the assembly 180° or front to back.

□□ **[Illustration 39]** Use a jack for support and swing the lower control up to attach the lower end of the strut to the lower control arm using the factory hardware. Install bolt front-to-rear. Snug, but do not tighten. [bolt: 27mm | nut: 30mm]

□□ **[Illustration 38]** Tighten the 3 top strut 10mm nuts. (37) [15mm]

Attach Strut Spacer...

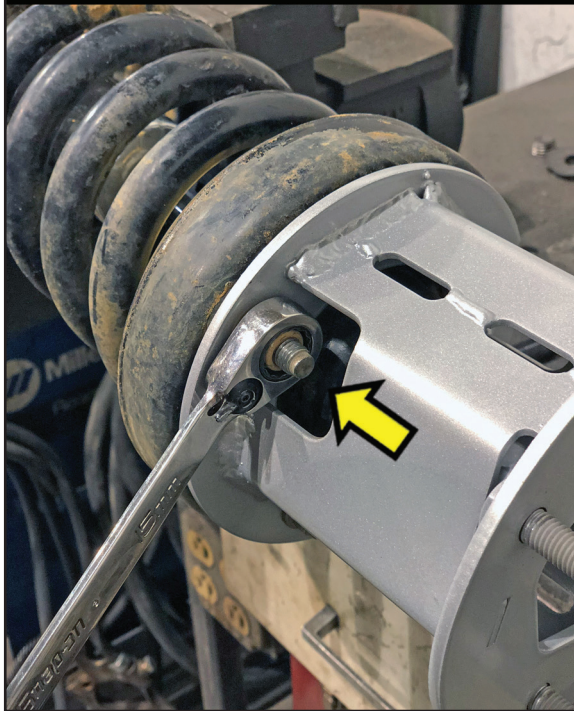

[Illustration 38]

Install Upper Strut Mount... Driver Side

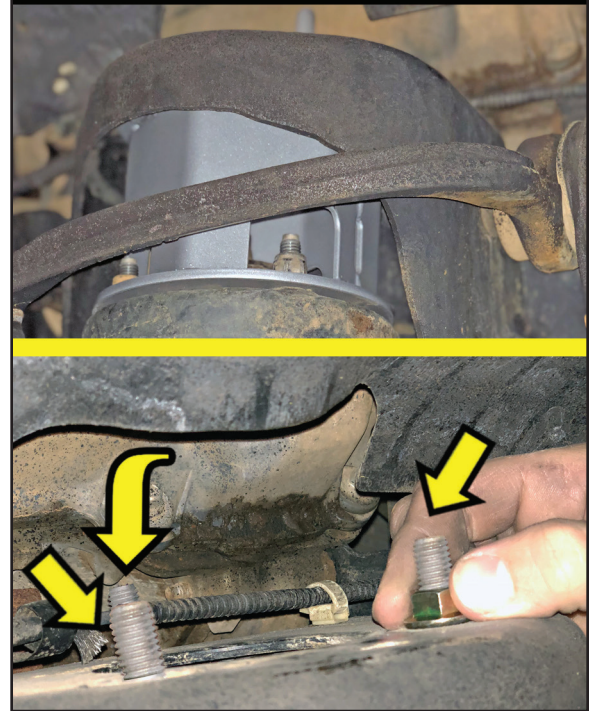

[Illustration 39]

Install Lower Strut Mount... Driver Side

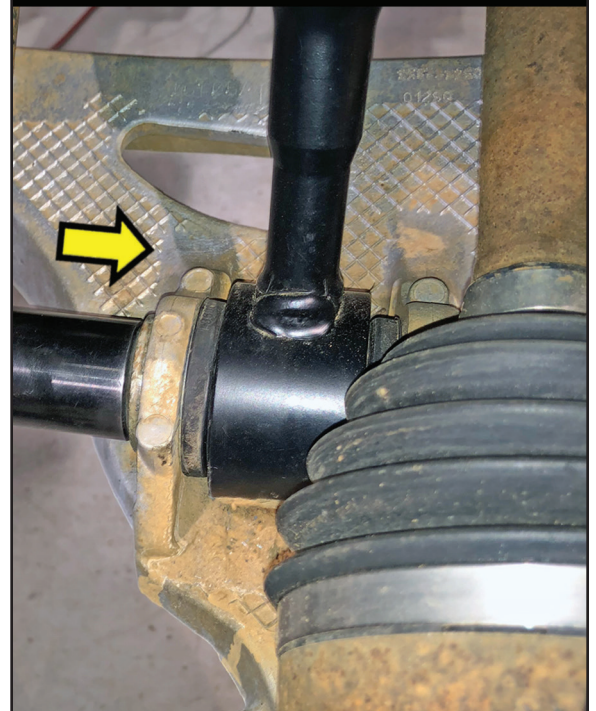

26) STRUT SPACER WITH BILSTEIN STRUT...

⚠ WARNING: Extreme care must be taken during the following steps. The struts have a tremendous amount of energy stored in them and can cause serious injury or even death if an attempt is made to work on them without the proper tools. Disassembly & assembly of the struts can only be performed by a qualified professional with the special equipment designed for this task. If necessary, the struts can be removed from the vehicle and taken to a shop with the proper equipment to have the necessary work performed.

⚠ NOTE: A factory service manual should be on hand for reference. Perform the strut assembly and installation one side at a time.

Locate the SUPERLIFT (2) strut spacers (#55-34-9940). Locate Hardware Bag #77-9942. Hardware PER Side: (3) 10mm flange nuts.

Locate the BILSTEIN (2) struts (#24-239363).

☐☐ Place the factory strut assembly in a heavy-duty strut compressor and compress the coil spring enough to unload the shock. Remove the retaining nut on the upper shock mount and carefully remove the strut cylinder.

☐☐ Tap the compression stop cap off of the factory strut body and remove the lower spring seat. This seat will be re-used.

☐☐ Make careful note of the order and orientation of all the factory pieces for proper re-assembly. Remove all of the factory components from the original strut that will be re-used, including the upper and lower spring seats and compression stop.

☐☐ [DIAGRAM 1] Remove the replacement strut (#24-239363) and hardware pack from its packaging. **⚠ NOTE:** The strut has three (3) machined grooves in its body. Position the supplied snap ring in the appropriate groove for the desired amount of lift:

FOR the 6" LIFT - Position the supplied snap ring in the TOP Groove (Closest to the Strut Rod Upper Mount).

FOR the 4.5" LIFT - Position the supplied snap ring in the BOTTOM Groove (Closest to the Strut Eye Lower Mount).

☐☐ Position the supplied spring seat holder on the strut body with the tapered end facing up. Note that the bottom end of the spring seat holder has a groove machined into it; the snap ring on the strut should recess into this groove. Verify that the supplied snap ring is properly seated in the top groove on the strut body.

☐☐ Install the factory lower spring seat on the strut, then tap the supplied compression stop cap on to the strut body. Slide the factory compression stop on the shock rod, then install the supplied rubber sleeve and steel spacer on the stem of the shock.

☐☐ Install the spring, upper spring seat, and the remaining factory components. Position the studs of the upper spring seat in the same orientation relative to the lower shock eye as they were prior to disassembly. Compress the assembly enough to install the supplied retaining nut, tighten (37), then carefully unload the strut.

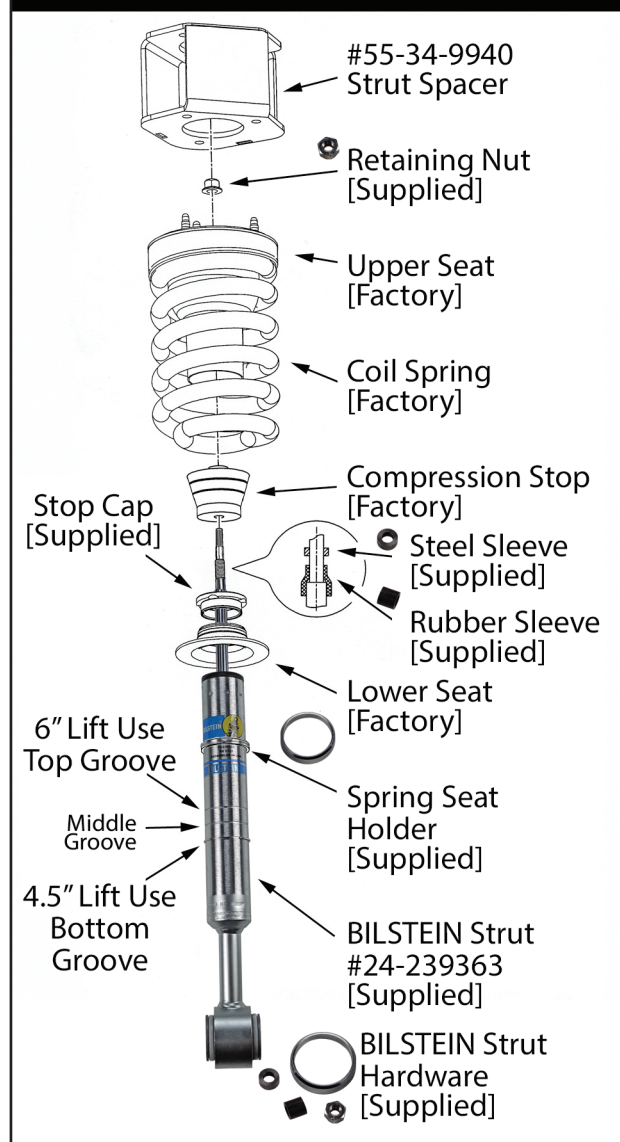
[DIAGRAM 1]**6" BILSTEIN Strut Assembly...**

☐☐ [Illustration 37] Attach the new strut spacer (55-34-9940) to the top of the strut assembly using the factory hardware and tighten the factory nuts. [15mm] (37)

☐☐ [Illustration 38] Slide the strut assembly through the upper control arm and locate the upper end of the assembly into the frame mount properly. Secure the upper end of the assembly using the supplied 10mm flange nuts. Snug, but do not tighten. [15mm] **TECH TIP** The strut assembly will only fit one way. Rotate the assembly 180° or front to back.

☐☐ [Illustration 39] Use a jack for support and swing the lower control up to attach the lower end of the strut to the lower control arm using the factory hardware. Install bolt front-to-rear. Snug, but do not tighten. [bolt: 27mm | nut: 30mm]

☐☐ [Illustration 38] Tighten the 3 top strut 10mm nuts. (37) [15mm]

27) KNUCKLE ASSEMBLY...

⚠ NOTE: Perform these Steps on One Knuckle at a Time.

Locate the SUPERLIFT (2) knuckles. Driver side (#66-01-9940) & passenger side (#66-02-9940).

Locate Hardware Bag #77-9940. Hardware PER Side: (1) #F470L thread locker.

Locate the factory knuckles. Note the orientation of the dust shield, vacuum module and wheel bearing assembly prior to removal.

☐☐ [Illustration 40] Remove the (3) bolts securing the vacuum hub to the factory knuckle and remove. [8mm]

[Illustration 40]

Remove Vacuum Hub...

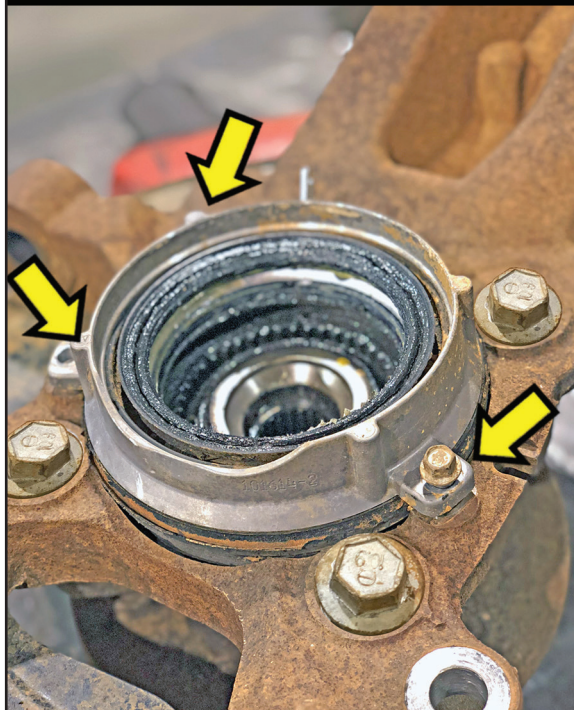

☐☐ [Illustration 41] Remove the (4) bolts securing the wheel bearing assembly and remove. [18mm]

[Illustration 41]

Remove Wheel Bearing...

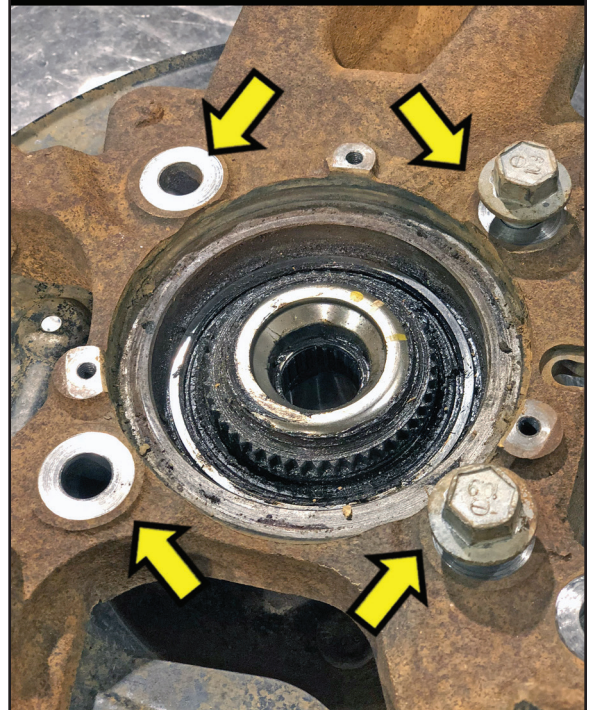

☐☐ [Illustration 42 & 43] Remove the (3) bolts securing the brake dust shield and remove. [8mm] Install the dust shield onto the new knuckle using the factory hardware. Be sure the orientation of the dust shield matches original assembly.

☐☐ [Illustration 44] Apply thread locker to the (4) factory wheel bearing assembly bolts. Place the new knuckle onto the wheel bearing assembly and secure. Tighten. [18mm] (151)

☐☐ [Illustration 45] Apply thread locker to the (3) factory vacuum hub assembly bolts. Place the factory vacuum hub onto the new knuckle and secure. Tighten. [8mm]

[Illustration 42]

Remove Dust Shield...



[Illustration 43]

Install Dust Shield...

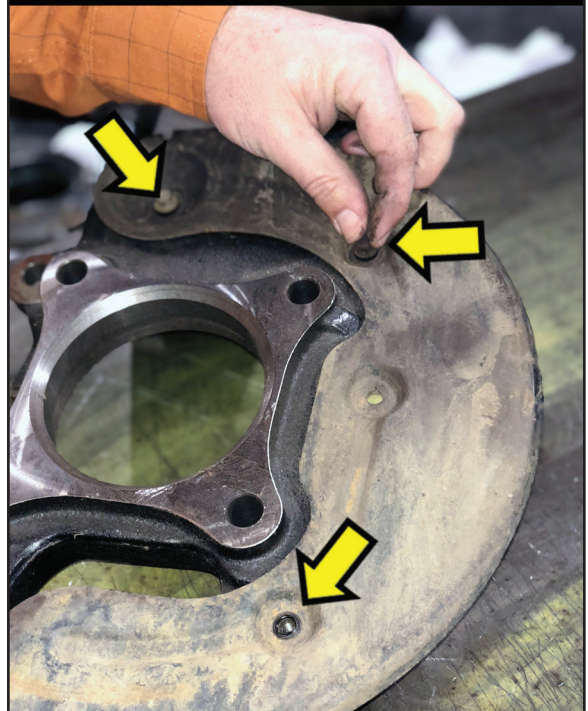

[Illustration 44]

Install Wheel Bearing...

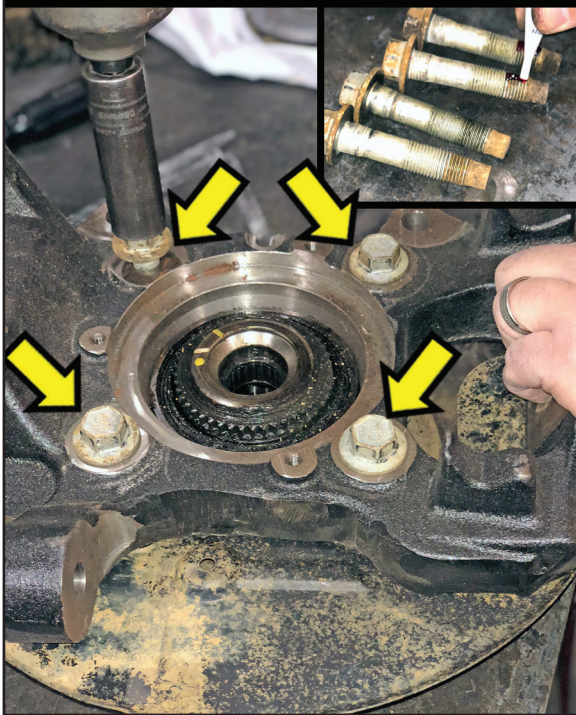

[Illustration 45]

Install Vacuum Hub...

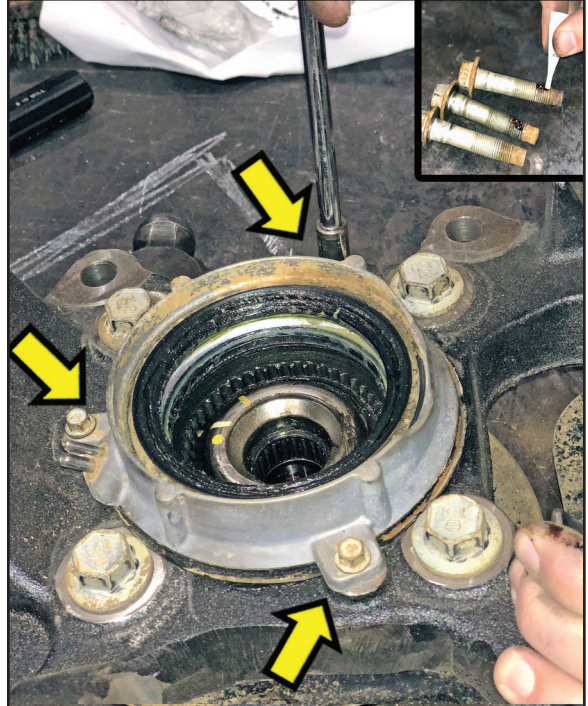

28) KNUCKLE INSTALLATION...

☐☐ [Illustration 46] Install the knuckle assembly on the lower ball joint while sliding the CV shaft into the new knuckle.

⚠NOTE: Carefully position the vacuum assembly on the CV shaft. Connect the upper ball joint to the knuckle and secure using the factory nuts. [upper ball joint 21mm, lower ball joint 24mm] Tighten the lower nut (94) and the upper nut (37).



29) AXLE SHAFT...

☐☐ [Illustration 47] Secure the CV axle shaft to the knuckle with the factory nut and tighten. [13mm] (148-165). Reinstall the dust cap over the axle nut. [flat screwdriver]

30) ABS WIRING...

- ☐☐ [Illustration 48] Disconnect the ABS sensor line from the brake it's clips on the brake hose.
- ☐☐ [Illustration 49] Follow the ABS line up and disconnect it from the upper bracket.
- ☐☐ [Illustration 50] Continue to follow the line up and disconnect it from the clip attached to the inner fender liner.

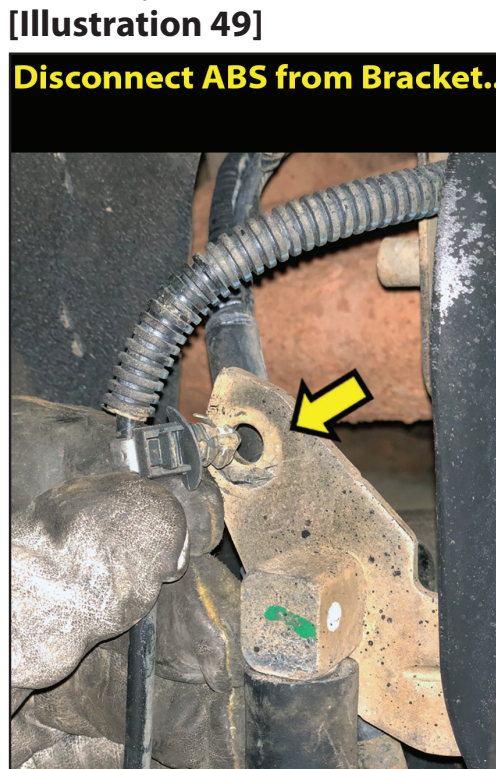
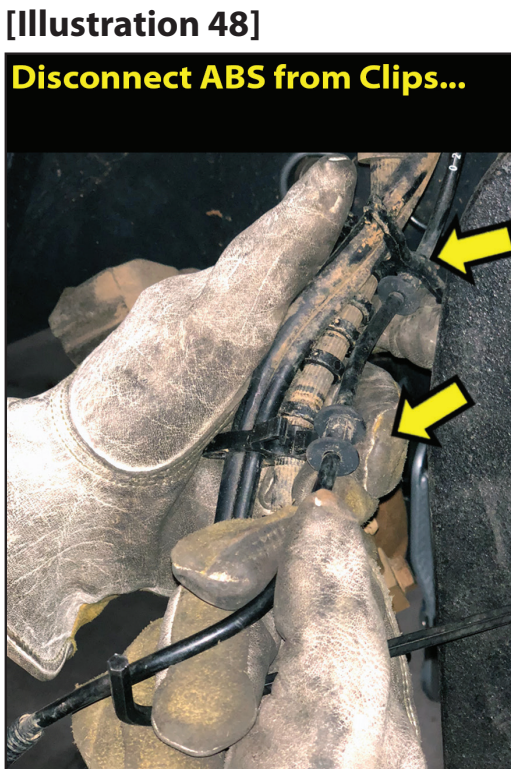

31) ATTACH ABS SENSOR TO KNUCKLE...

□□ [Illustration 51] Located on the rearward side of the knuckle, attach the ABS sensor to the knuckle. Secure the ABS sensor to the hub assembly using the factory hardware. [5mm Allen] (1)

32) REATTACH HUB VENT TUBES...

□□ [Illustration 52] Located on the back side of the knuckle, reconnect the two (2) vent tubes to the hub assembly.

33) BRAKE HOSE BRACKET...

Locate the SUPERLIFT (2) front brake line relocation brackets. Driver side (#55-36-9940) & passenger side (#55-37-9940).

Locate Hardware Bag #77-9941. Hardware PER Side: (2) 5/16" x 3/4" bolt, coarse thread, (2) 5/16" Nyloc nut, (2) 5/16" washer, SAE, (1) 1/4" x 3/4" bolt, coarse thread, (1) 1/4" Nyloc nut & (1) 1/4" washer, SAE

□□ [Illustration 53] Remove the factory brake line bracket from the frame located on the rearward side of the upper control arm mount. [10mm]

□□ [Illustration 54] Attach the SUPERLIFT

brake line relocation bracket to the factory brake hose location on the frame. Secure using the factory hardware in the lower hole of the bracket. Use the supplied 5/16" x 3/4" bolt, washer, and Nyloc nut in the upper hole. Snug, but do not tighten both mounts. [10mm, 1/2"]

[Illustration 51]

Attach ABS to Knuckle... Passenger Side

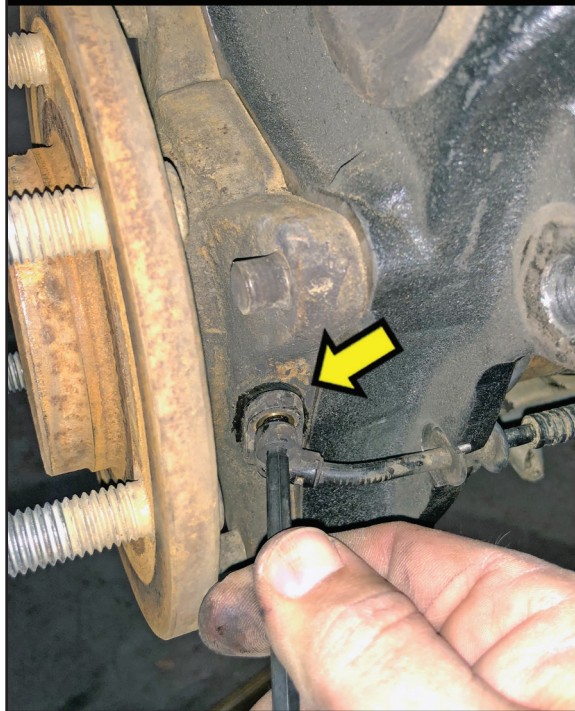

[Illustration 52]

Attach Hub Vent Tubes... Passenger Side

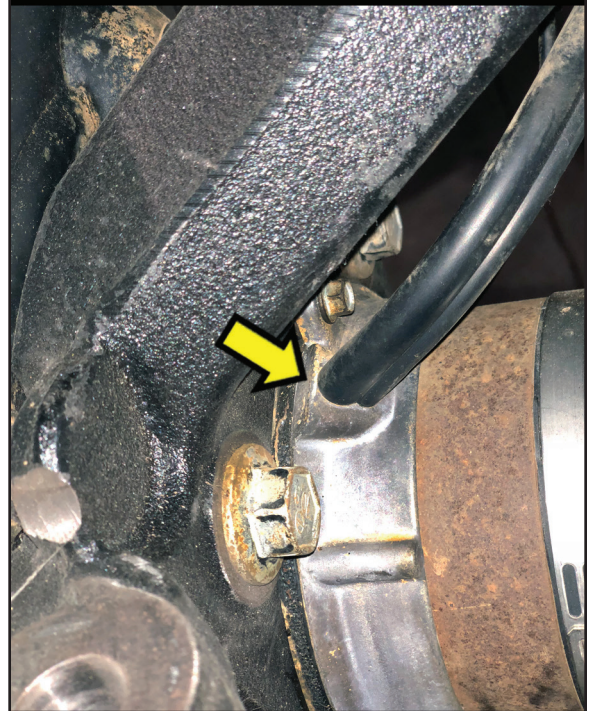

[Illustration 53]

Remove Brake Hose Bracket... Driver Side



[Illustration 54]

Attach Brake Hose Bracket... Driver Side

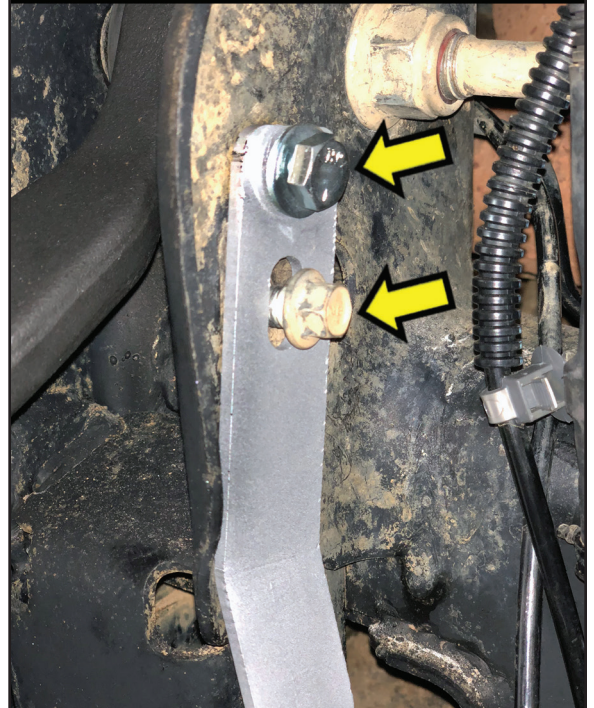

☐☐ [Illustration 55]

Fasten the factory brake hose bracket to the SUPERLIFT bracket using the supplied 1/4" x 3/4" bolt, washer, and Nyloc nut. Snug, but do not tighten. [7/16"]

⚠ NOTE: Make sure there is adequate slack in the ABS and vent hose to route along the brake hose, then zip tie the brake hose securely and in a safe position. The ABS line and brake hose may have to be removed from additional line clips to gain adequate slack.

☐☐ Tighten all hardware.

SUPERLIFT brake line relocation bracket to the factory brake hose location on the frame. [10mm, 1/2"] (factory bolt: 20; 5/16" bolt 30)

Factory brake hose bracket to the SUPERLIFT bracket [7/16"] (8)

34) BRAKE ROTOR...

☐☐ [Illustration 56]

Install the brake rotor.

🔧 TECH TIP Secure with a lug nut at the bottom, lower stud.

35) BRAKE CALIPER...

☐☐ [Illustration 57]

Apply thread locker to the (2) factory bolts. Attach the caliper bracket assembly to the knuckle. Tighten [18mm] (129)

⚠ NOTE: Remember to remove the factory lug nut.

36) STEERING TIE ROD END...

☐☐ [Illustration 58] Attach the tie rod end to the new knuckle using the factory nut. Tighten. [21mm] (44)

[Illustration 55]

Attach Brake Hose Brackets... Driver Side



[Illustration 56]

Install Brake Rotor... Driver Side



[Illustration 57]

Install Brake Caliper... Passenger Side

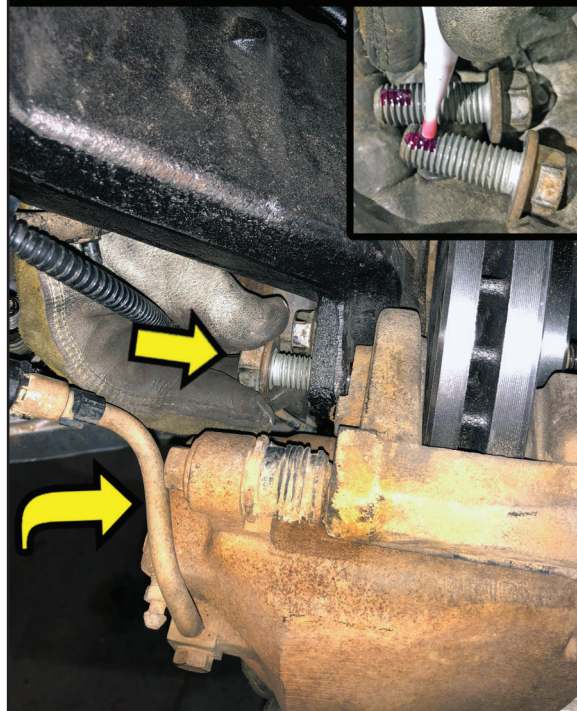

[Illustration 58]

Attach Tie Rod End... Driver Side

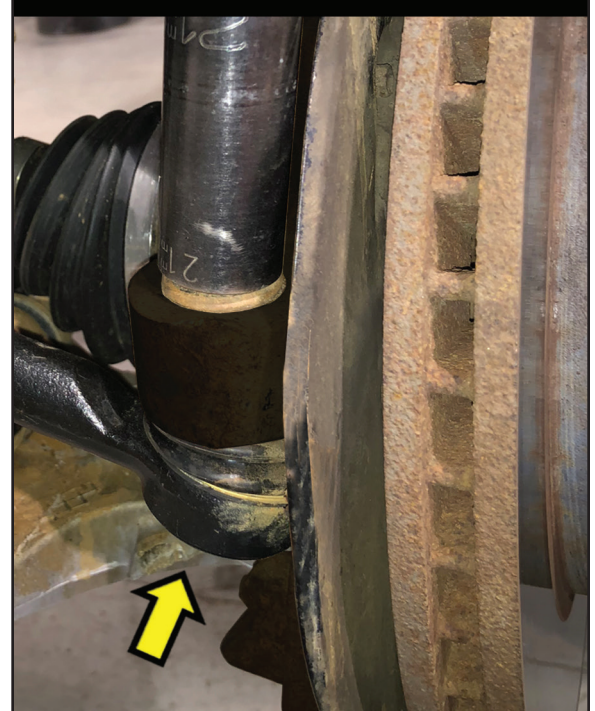

37) ATTACH SWAY BAR... BAR...

Locate the the factory sway bar tab bolts and nuts. Locate the sway bar link bushings and nuts.

[Illustration 59]

Place the factory tab bolt down into the SUPERLIFT sway bar brackets. **NOTE:**

Make sure the orientation of the sway bar is positioned correctly: Driver & passenger side.

[Illustration 59]

Place the end of the sway bar over the sway bar link attached to the lower control arm. Swing the sway bar up into position and attach the factory sway bar bushing plate and sway bar body to the SUPERLIFT sway bar bracket. [15mm]

[Illustration 60] Tighten the sway bar to SUPERLIFT sway bar bracket. Tighten. [15mm] Reinstall the factory sway bar link with the factory bushing and nut. Snug, but do not tighten. [15mm]

[Illustration 61] Tighten the lug nuts. [Lug Nuts 21mm] (151)

38) INSTALL FRONT TIRES \ WHEELS...

[Illustration 61] Tighten the lug nuts. [Lug Nuts 21mm] (151)

WARNING: When the tires\wheels are installed, always check for and remove any corrosion, dirt, or foreign material on the wheel mounting surface, or anything that contacts the wheel mounting surface (hub, rotor, etc.). Installing wheels without the proper metal-to-metal contact at the wheel mounting surfaces can cause the lug nuts to loosen and the wheel to come off while the vehicle is in motion.

WARNING: Retighten lug nuts at 500 miles after any wheel change, or anytime the lug nuts are loosened. Failure to do so could cause wheels to come off while vehicle is in motion.

Lower vehicle to the floor. The suspension is now supporting the vehicle's weight.

[Illustration 59]

Attach Sway Bar Body... Driver Side

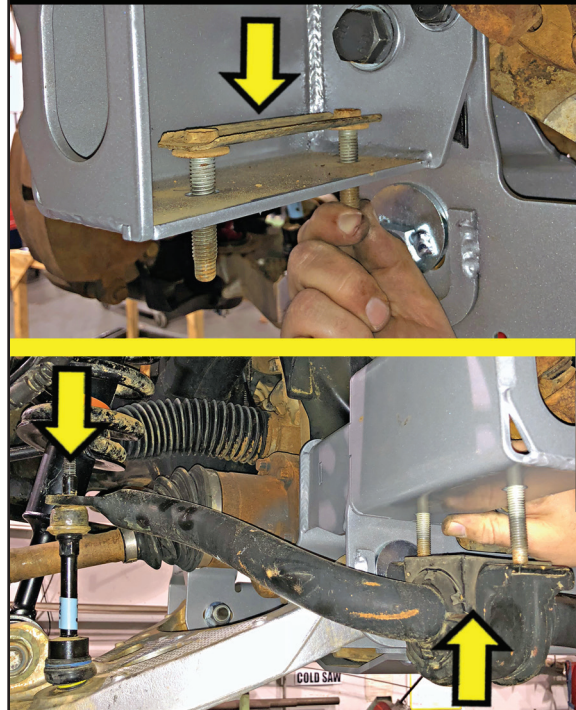

[Illustration 60]

Attach Sway Bar... Driver Side

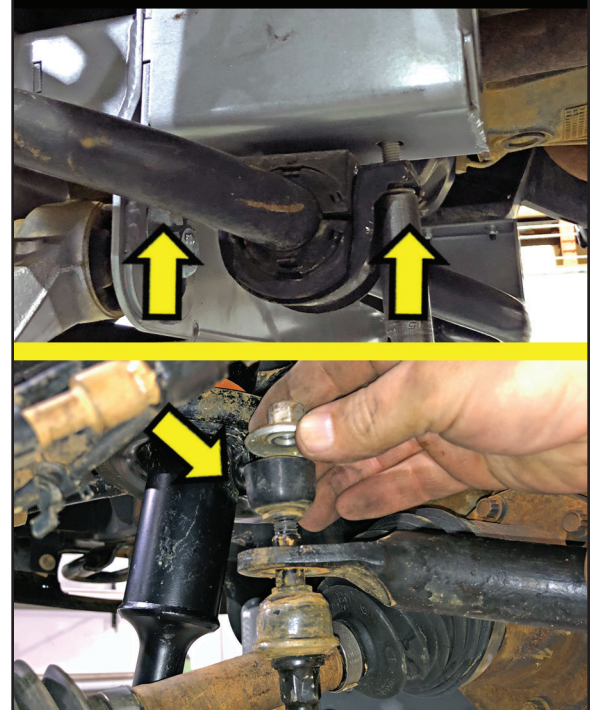

[Illustration 61]

Lug Nut Torque Sequence... Follow the Sequence Below to Torque the Lug Nuts

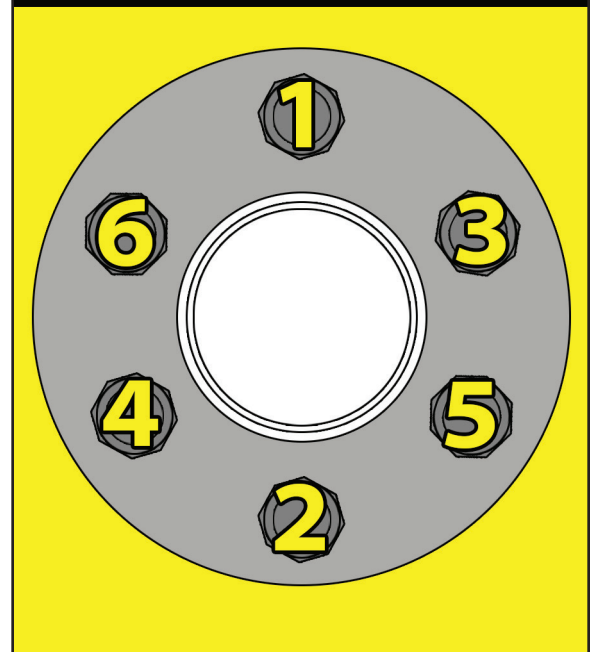

39) TIGHTEN LOWER CONTROL ARM...

[Illustration 62] Tighten the four lower control arm bolts (2 Per Side: **NOTE:** Make sure the cam washers fit between the control tabs on the crossmembers. The cam washer should be in the up or neutral position until the alignment is performed. [27mm] (240)

40) TIGHTEN SWAY BAR LINK...

[Illustration 63] Tighten sway bar to sway bar link. Tighten until the bushings swell slightly. [15mm] (63)

[Illustration 62]

**Tighten Lower Control Arms...
Driver Side, Rear**

[Illustration 63]

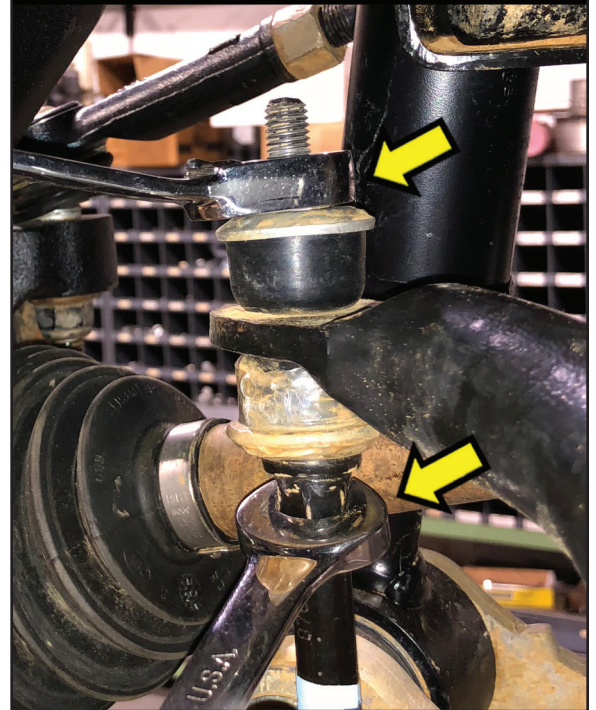
**Tighten Sway Bar Link...
Driver Side**

[Illustration 64]

**Remove Rear Shocks...
Driver Side****REAR DISASSEMBLY****41) PREPARE VEHICLE...**

Chock the front tires. Position a jack beneath the center of the rear axle of the vehicle. Raise rear of vehicle and place jack stands beneath the frame rails just forward of the rear springs' front hangers. Ease the jack down until the frame is resting on the stands. Keep a slight load on the jack. Remove the rear tires.

42) SHOCK ABSORBERS...

[Illustration 64] Remove the shock absorbers. [bolt: 15mm | nut: 18mm] Discard shocks.

43) BRAKE LINE BRACKET...

[Illustration 65] Unbolt the rear brake hose bracket from the driver side frame rail. This bracket secures the connection between the metal brake lines and rubber hoses at the frame. [10mm]

[Illustration 66]

Follow the brake line up to the frame. Unclip the brake line clip from the driver side frame rail. [Plastic Fastener Removal Tool]

44) REMOVE FACTORY BLOCKS...

[Illustration 67]

Remove ubolts and then lower the axle several inches away from springs. [21mm] Discard the ubolts and hardware. Maintain the lower ubolt plate.

Clean spring pads of all debris.

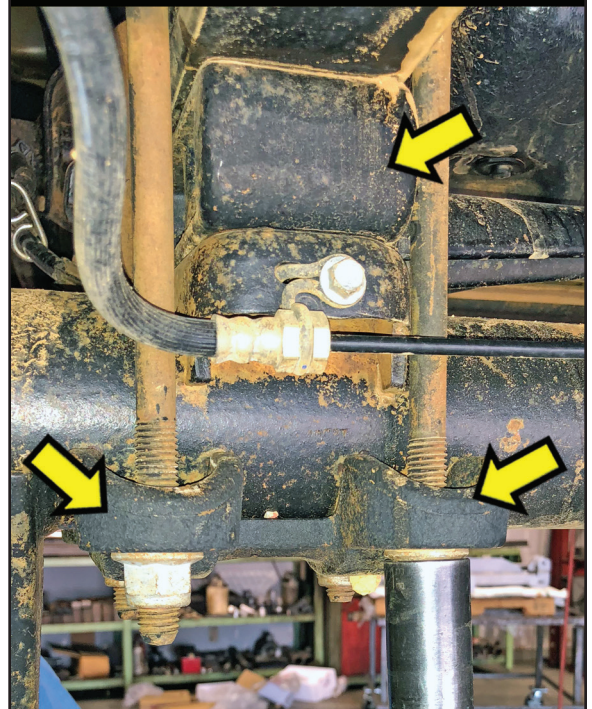
[Illustration 65]**Unbolt Brake Line Bracket...
Driver Side****[Illustration 66]****Unclip Brake Line Clip..
Driver Side****[Illustration 67]****Remove Factory Rear Block..
Driver Side**

REAR ASSEMBLY

45) LIFT BLOCKS AND UBOLTS...

FOR the 4.5" LIFT - Locate the SUPERLIFT (2) 55-30-9930 rear blocks. Locate the (4) #10342 - 9/16" x 3-5/16" x 10" square ubolts.

FOR the 6" LIFT - Locate the SUPERLIFT (2) 55-31-9930 rear blocks. Locate the (4) #10362 - 9/16" x 3-5/16" x 12" square ubolts.

Locate Hardware Bag #77-1509. Hardware PER Side: (4) 9/16" high nut, fine thread & (4) 9/16" ubolt washers.

[Illustration 68] Position the appropriate SUPERLIFT block for the desired lift on top of the axle pad. **NOTE:** The 'notched' edge of the block goes toward the 'front'.

Using the floor jack(s), mate the springs to the blocks, be sure that the center bolt heads seat properly. Install the new SUPERLIFT 9/16" u-bolts, factory ubolt plate and supplied ubolt washers & high nuts. Evenly torque the ubolts using an "X" tightening sequence. (150) [7/8"]

46) SHOCK ABSORBERS...

Locate the SUPERLIFT (2) #01-85150 (650341) shocks. Locate Hardware Bag #77-87037. Hardware PER Side: (2) #01-60418, hourglass bushings & (2) # 24-5704, 0.75" OD x 0.50" ID x 1.54" L, sleeves.

If installing the SUPERLIFT shocks, install the supplied # 01-60418 hourglass bushings into the shock eyes. Then install the #24-5704, 0.75" OD x 0.50" ID x 1.54" L sleeves into the shock eyes.

OR Locate the BILSTEIN (2) #33-185569 shocks.

[Illustration 69] Install the new shocks (01-85150 SUPERIDE or 33-185569 BILSTEIN 5100 SERIES) into the factory location with the factory hardware. [bolt: 15mm | nut: 18mm] (55)

NOTE: SUPERLIFT brand shocks must be installed with the cylinder body mounted at the axle. [Shaft UP, Body DOWN] BILSTEIN can be mounted Shaft Up or Shaft Down.

Install the SUPERLIFT shock decals.

[Illustration 68]

Install Rear Block & Ubolts... Driver Side



[Illustration 69]

Install Rear Shocks... Driver Side



47) BRAKE LINE BRACKET...

Locate Hardware Bag #77-9941A. Hardware PER Side: (1) #38-9940 brake line bracket, rear.

Locate Hardware Bag #77-9941. Hardware PER Side: (1) 5/16" x 3/4" bolt, coarse thread, (1) 5/16" Nyloc nut & (1) 5/16" washer, SAE.

[Illustration 70] Attach #38-9940 brake line bracket to the frame in the factory bracket position using the factory bolt. [10mm].

⚠️ NOTE: The 'notched' edge of the bracket goes to the 'top'.

Attach the factory brake line bracket to the new bracket using the supplied 5/16" x 3/4" bolt, washer and Nyloc nut. The factory bracket tab goes in the bottom hole and the 5/16" bolt goes in the hole above it.

48) TIRES / WHEELS...

[Illustration 61] Reinstall tires and wheels. Tighten the lug nuts in the sequence shown. (151) [21mm]

⚠️ WARNING: When the tires / wheels are installed, always check for and remove any corrosion, dirt, or foreign material on the wheel mounting surface, or anything that contacts the wheel mounting surface (hub, rotor, etc.). Installing wheels without the proper metal-to-metal contact at the wheel mounting surfaces can cause the lug nuts to loosen and the wheel to come off while the vehicle is in motion.

⚠️ WARNING: Retighten lug nuts at 500 miles after any wheel change, or anytime the lug nuts are loosened. Failure to do so could cause wheels to come off while vehicle is in motion.

Lower vehicle to the floor.

49) BATTERY...

Reconnect battery.

50) ALIGNMENT...

Realign vehicle to factory specifications.

51) CLEARANCE CHECKS...

With the vehicle on the ground, cycle steering lock-to-lock and check all components for proper operation and clearances. Pay special attention to the clearance between the tires\wheels and knuckles, brake hoses, wiring, etc.

Raise the vehicle back onto jack stands and chock rear tires and place transmission in neutral. Raise front of vehicle with a jack and secure a jack stand beneath each frame rail. With the suspension "hanging" at full extension travel, cycle steering lock-to-lock and check all components for proper operation and clearances. Pay special attention to the clearance between the tires\wheels and knuckles, brake hoses, wiring, etc.

52) FOUR WHEEL DRIVE...

Activate the four wheel drive system and check for proper engagement.

53) HEADLIGHTS...

Re-adjust headlights to proper setting.

54) SUPERLIFT WARNING DECAL...

⚠️ WARNING: Install the WARNING TO DRIVER decal on the inside of the windshield, or on the dash, within driver's view.

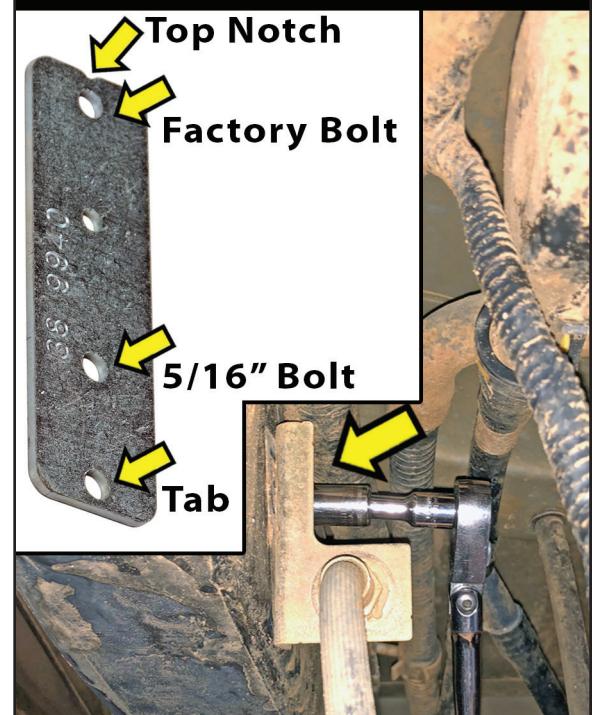
[Illustration 70]**Attach Brake Line Bracket...
Driver Side**

IMPORTANT MAINTENANCE INFORMATION

⚠️ WARNING: It is the ultimate buyer's responsibility to have all bolts / nuts checked for tightness after the first 100 miles and then every 1000 miles. The steering, suspension and driveline systems, plus wheel alignment should be inspected by a qualified professional mechanic at least every 3000 miles.

LIMITED LIFETIME WARRANTY / WARNINGS

Your SUPERLIFT® product is covered by the Limited Warranty explained below that gives you specific legal rights. This limited warranty is the only warranty SUPERLIFT® makes in connection with your product purchase. SUPERLIFT® neither assumes nor authorizes any retailer or other person or entity to assume for it any other obligation or liability in connection with this product or limited warranty.

SUPERLIFT, LLC, LIMITED LIFETIME WARRANTY

What is covered? Subject to the terms below, SUPERLIFT® will repair or replace its products found defective in materials or workmanship for so long as the original purchaser owns the vehicle on which the product was originally installed. Your warranter is SUPERLIFT, LLC, doing business as SUPERLIFT® Suspension Systems ("SUPERLIFT®").

What is not covered? Your SUPERLIFT® Limited Warranty does not cover products SUPERLIFT® determines to have been damaged by or subjected to:

- Alteration, modification or failure to maintain.
- Normal wear and tear (bushings, rod ends, etc.). Scratches or defects in product finishes (powder coating, plating, etc.).
- Damage to, or resulting from, the vehicle's electronic stability system, related components or other vehicle systems.
- Racing or other vehicle competitions or contests. Accidents, impact by rocks, trees, obstacles or other aspects of the environment.
- Theft, vandalism or other intentional damage.

Remedy Limited to Repair or Replacement. The exclusive remedy provided hereunder shall, upon SUPERLIFT's inspection and at SUPERLIFT's option, be either repair or replacement of the product covered under this Limited Warranty. Customers requesting warranty consideration should contact SUPERLIFT® by phone (1-800-551-4955) to obtain a Returned Goods Authorization number. All removal, shipping and installation costs are customer's responsibility.

If a replacement part is needed before the SUPERLIFT® part in question can be returned, you must first purchase the replacement part. Then, if the part in question is deemed warrant-able, you will be credited / refunded.

OTHER LIMITATIONS - EXCLUSION OF DAMAGES - YOUR RIGHTS UNDER STATE LAW

- Neither SUPERLIFT® nor your independent SUPERLIFT® dealer are responsible for any time loss, rental costs, or for any incidental, consequential or other damages you may have.
- This Limited Warranty gives you specific rights, and this is the only warranty SUPERLIFT® makes in connection with your product purchase. You may also have other rights that vary from state to state. For example, while all implied warranties are disclaimed herein, any implied warranty required by law is limited to the terms of our Limited Lifetime Warranty as described above. Some states do not allow limitations of how long an implied warranty lasts and / or do not allow the exclusion or limitation of incidental or consequential damages, so the limitations and exclusions herein may not apply to you. SUPERLIFT® neither assumes nor authorizes any retailer or other person or entity to assume for it any other obligation or liability in connection with this product or Limited Warranty.

IMPORTANT PRODUCT USE AND SAFETY INFORMATION / WARNINGS

⚠️ WARNING: As a general rule, the taller a vehicle is, the easier it will roll over. Offset, as much as possible, what is lost in rollover resistance by increasing tire track width. In other words, go “wide” as you go “tall”; always use as wide a tire and wheel combination as feasible to enhance vehicle stability. We strongly recommend, because of rollover possibility, that the vehicle be equipped with a functional roll bar and cage system. Seat belts and shoulder harnesses should be worn at all times. Avoid situations where a side rollover may occur.

Generally, braking performance and capabilities are decreased when significantly larger / heavier tires and wheels are used. Take this into consideration while driving. Also, changing axle gear ratios or using tires that are taller or shorter than factory height will cause an erroneous speedometer reading. On vehicles equipped with an electronic speedometer, the speed signal impacts other important functions as well. Speedometer recalibration for both mechanical and electronic types is highly recommended.

Do not add, alter, or fabricate any factory or aftermarket parts to increase vehicle height over the intended height of the SUPERLIFT® product purchased. Mixing component brands is not recommended.

⚠️ NOTE: WE WANT TO SEE YOUR RIDE...

Grab photos of your SUPERLIFT Equipped truck in various poses and in action.

Email pictures to us at sales@superlift.com

Tag us on **Facebook:** [@superlift suspension systems](https://www.facebook.com/superliftsuspension)

Tag us on **Instagram:** [#superlift](https://www.instagram.com/superlift), [#superliftsuspension](https://www.instagram.com/superliftsuspension), [#superliftequipped](https://www.instagram.com/superliftequipped)

THANKS For Choosing SUPERLIFT...

For questions, technical support and warranty issues relating to this SUPERLIFT products, please contact SUPERLIFT directly.

SUPERLIFT SUSPENSION
300 Huey Lenard Loop Rd.
West Monroe, Louisiana 71292
Phone: (318) 397-3000
Sales / Tech: (800) 551-4955
Fax: (318) 397-3040
SUPERLIFT.COM