



STEP 1 – PRIOR TO INSTALLATION

- A) Bushwacker only** approves installing the flares according to these written instructions with the hardware provided. **WARNING:** Failure to install according to these instructions will invalidate the warranty. This includes, but is not limited to using alternative installation methods, hardware, or materials. **DO NOT USE:** Loctite, SuperGlue, or similar products on the hardware or the flares.
- B) Fit:** Verify the fit of the flares to vehicle. (Some filing, sanding, or cutting may be necessary to ensure proper fit).
- C) Painting:** (Optional) if paint is desired it must be done prior to installing flares on vehicle. Clean outer surface with a good grade degreaser. **DO NOT USE LACQUER THINNER OR ENAMEL REDUCER AS A DEGREASER.** Wipe outer surface thoroughly with a tack rag prior to paint. Application of plastic adhesion promoter for ABS plastic as per your paint system manufacturer's recommendations is required. Paint flares using a high quality enamel, or polyurethane automotive paint. If painting edge trim (not recommended), use a flex additive.
- D) Performance:** Using larger Tires may increase the area required to turn the vehicle. Some Tire/Rim combinations may require lowering bump stops and or installing steering stops to prevent tire from contacting flare.
- E) Exhaust System:** Modifications may be necessary to maintain a minimum 4" clearance between flares and exhaust pipes. (Exhaust gases should not vent directly onto flares)
- F) Metal Protection:** All exposed fasteners and bare metal should be treated with rust resistant paint **BEFORE** installing flares. Spray inner fender wells with undercoating **AFTER** flare attachments have been completed.
- G) Decals:** Flares may interfere with existing decals on vehicle. If you wish, remove decals prior to installation of flares.
- H) Care & Cleaning:** Bushwacker fender flares are built to last; any detergent you use to wash your vehicle is sufficient to clean the flare. Do not use any harsh abrasive detergents.

GMC Boss™ Pocket Style® Fender Flares Set of 4

Set Part #40928-02

Rev-9 2/16/2016

For complete fitment info visit : www.bushwacker.com

TOOLS FOR EASY INSTALLATION:











- 1/2" Wrench
- 7mm Socket
- #2 Phillips Driver
- Grease Pencil
- Awl (optional)
- Pry Tool

PLEASE READ: Dirt and debris can become lodged between the fender flares and the vehicle's fenders, causing scratching and paint wear from vibration. Lund International is not responsible for any damage, and the installation of our fender flares is done with the buyer's understanding that this scratching and paint wear may occur.

LIMITED LIFETIME WARRANTY AGAINST ANY MANUFACTURING DEFECTS

- To claim a warranty, you must provide Proof of Purchase.

Included in Hardware Kit:

- | | | | | | | |
|---|--|--|--|---|---|---|
| 1.

NU1-0007,
#12 "U" Spring
Nut,
4 pcs | 2.

CL1-0005,
Dacromet "S"
Spring Clip,
12 pcs | 3.

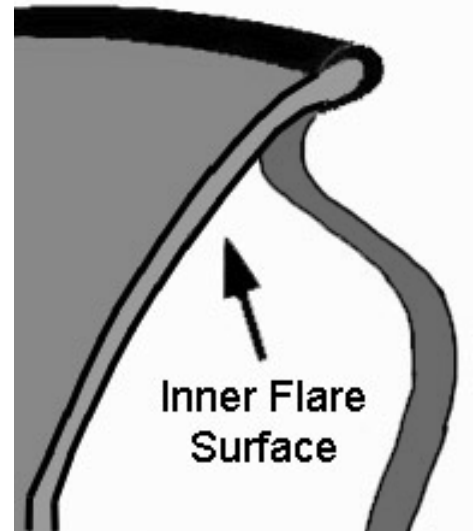
SW1-0057,
#14 x 3/4" Phillips
Truss Tap Screw,
4 pcs | 4.

SW1-0050,
10 x 5/16 Phillips
Truss Screw,
12 pcs | 5.

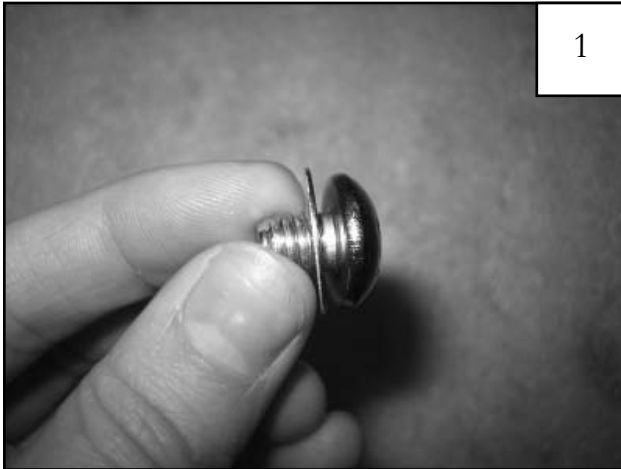
SW1-0067,
5/16 x 18 x 3/8"
SS Torx Screw,
38 pcs | 6.

WA1-0012,
.320 x .700 x .03
SS Washer,
38 pcs | 7.

NU1-0019,
5/16-18 Jam Fin.
Nylock Nut,
38 pcs |
| 8.

MT1-0002,
1" x 1" x .017"
Black Tab,
12 pcs | 9.

SW1-0052,
T-45 Torx Bit,
1 pc | 10.

GP1-0008,
Duro (NC02/S 70)
Edge Trim,
362 inches | | | | |

STEP 2 - EDGE TRIM INSTALLATION

- A)** Peel two to three inches of red vinyl backing away from Edge Trim (GP1-0008) tape. Applying the adhesive side of the edge trim to the inner side of the flare, affix the edge trim to the top edge of the flare (the portion that comes in contact with the vehicle).
- B)** Press edge trim into place along the top edge of the flare in one-foot increments, pulling red vinyl backing free as you continue to work your way around the top edge of the flare.



Pocket Hardware Installation Procedures:



Put a Washer (WA1-0012) on each Bolt (SW1-0059).



Put each Bolt through a pocket hole in the flare, bolt head on the outside.



Place a Nut (NU1-0019) over the end of each Bolt and tighten, using a 1/2" wrench for the Nut and the supplied Torx Bit (SW1-0052) for the Bolt. Repeat for remaining pockets.

Front Flare Installation Procedures (Driver's Side):

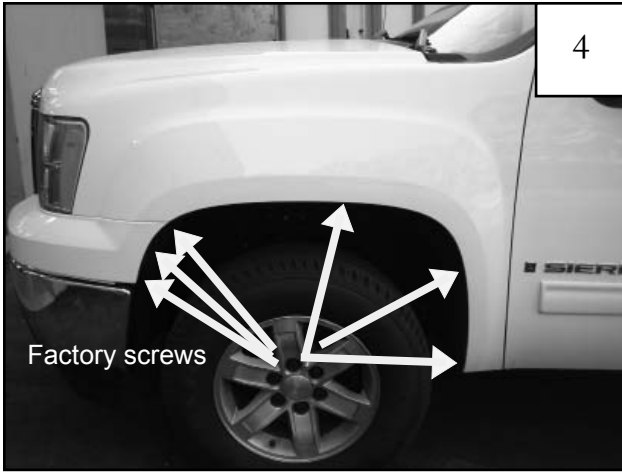

Using a 7mm socket, remove six factory screws from wheel well and save for reinstallation.



Position flare on fender and reinstall six factory screws removed in Step 4. If needed, use an awl to locate holes.



Completed front flare installation.

Rear Flare Installation Procedures (Driver's Side):



For 2011-UP ONLY: Using a pry tool remove factory installed tuflocs .



Tufloc locations

Note: If fender liner is installed remove factory tuflocs.



9

Holding flare in position on fender, use a grease pencil to mark eight hole locations.

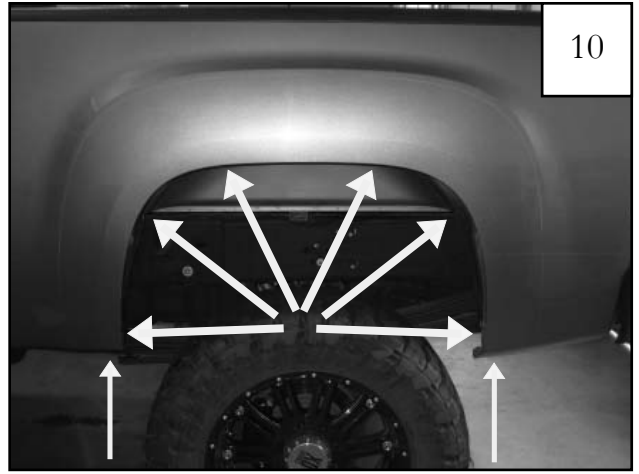

10

Eight hole locations.



11

Center a supplied Clip (NU1-0007) over the upper two marks made in Step 9. Clips may need to be adjusted to align with holes in flare. *Note: The raised collar on the Clip should face upward into the interior of the fender.*



12

Plastic Clip locations.

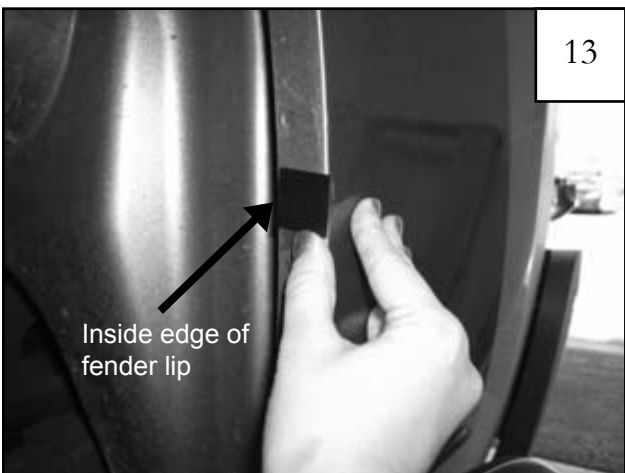

13

Inside edge of fender lip

Center a supplied Tab (MT1-0002) over the six remaining marks made in Step 9, aligning edge of Tab with inside edge of fender lip (Tab may extend over outside of fender).

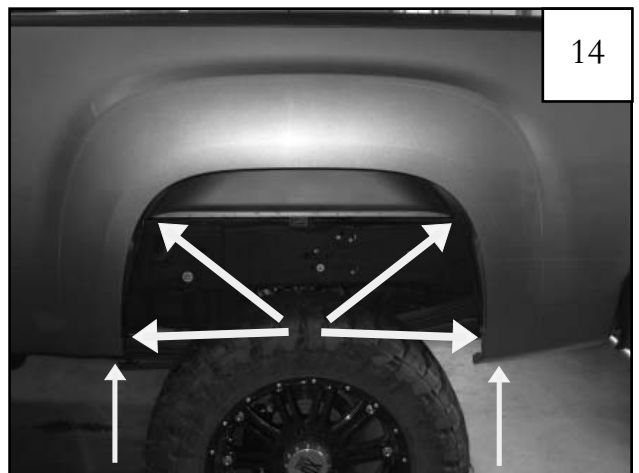

14

Tab locations.

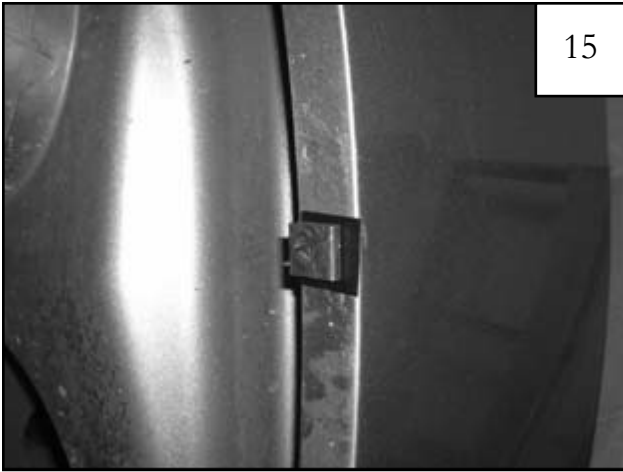

Slide a supplied Clip (CL1-0005) over each Tab. Clips may need to be adjusted to align with holes in flare.



Reposition flare on fender, Start a supplied Screw (SW1-0057) through the two uppermost holes in the flare and into each Clip installed in Step 11.



Start a supplied Screw (SW1-0050) through each of the remaining holes and into each Clip installed in Step 15. If needed, use scratch awl to locate holes.



Completed rear flare installation.